

Wireless Digital Flat Panel Detector

Mars1717V

User Manual

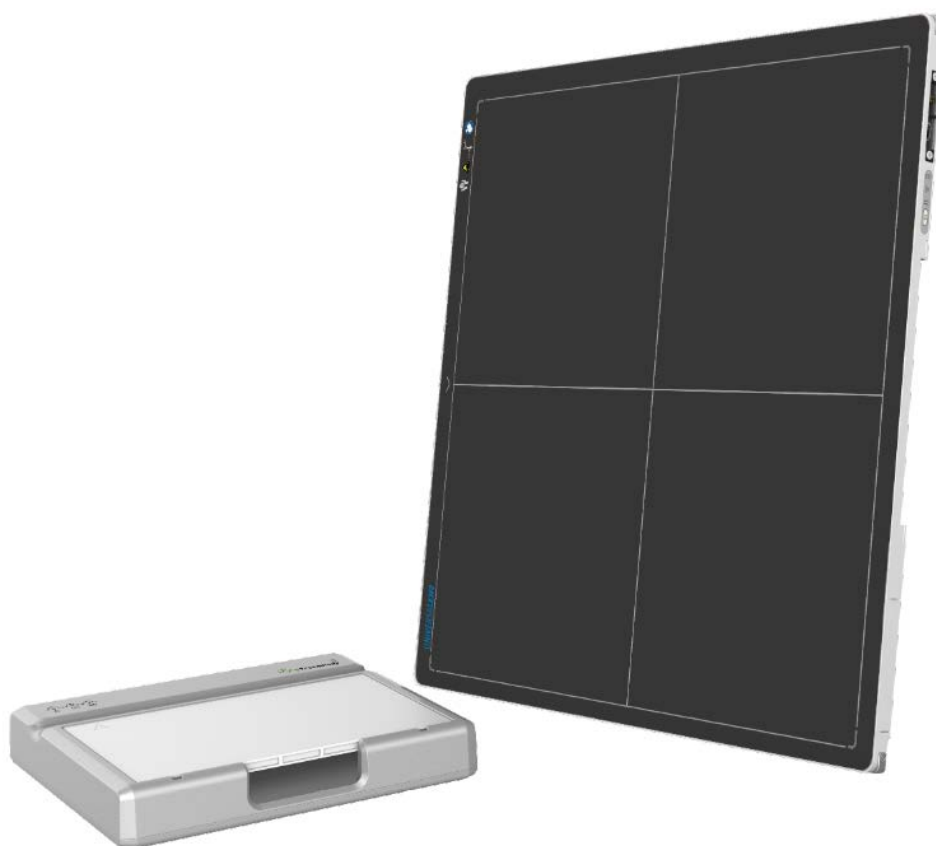

Document Version: A0

Document ID: 092-201-11

Release Date: 2021.01.05



Before operating, please read this user manual and pay attention to all safety precautions.

Please ensure that this user's manual is properly maintained so that it can be accessed at any time (reserve).

Please use it correctly on the basis of full understanding of the content.



About FCC

This device complies with Part 15 of the FCC Rules. Operation is subject to the following two conditions:

- (1) This device must not cause harmful interference;
- (2) This device must accept any interference received, including interference that may cause undesired operation.

Attention must be paid to the fact that changes or modifications not expressly approved by the party responsible for compliance can void the user's authority to operate the equipment.

Note: This product has been tested and found to comply with the limits for a Class B digital device, pursuant to Part 15 of the FCC Rules. These limits are designed to provide reasonable protection against harmful interference in a residential installation. This product generates, uses, and can radiate radio frequency energy and, if not installed and used in accordance with the instructions, may cause harmful interference to radio communications. However, there is no guarantee that interference will not occur in a particular installation. If this product does cause harmful interference to radio or television reception, which can be determined by turning the equipment off and on, the user is encouraged to try to correct the interference by one or more of the following measures:

- Reorient or relocate the receiving antenna.
- Increase the separation between the equipment and receiver.
- Connect the equipment to an outlet on a circuit different from that to which the receiver is connected.
- Consult the dealer or an experienced radio/TV technician for help.

About SAR

This equipment complies with FCC exposure limits set forth for an uncontrolled environment.

To Customers

Congratulations on your purchase of the Fixed Digital Flat Panel (hereinafter referred to as Mars1717V) which is manufactured by iRay Technology Co.Ltd. (Hereinafter referred to as iRay).



At iRay, we strive to not only make the world-class products that deliver the best value possible to our customers but also offer the highest quality of service and customer care. Please take time to read through this user guide in order to utilize the product effectively. We hope you enjoy the experience with iRay Mars1717V (configuration: Mars1717V3) .

If you have any questions or suggestions, please feel free to contact us.

Service Office
Tel: +86 21 50720560
Fax: +86 21 50720561
E-mail: service@iraygroup.com
Location: No.33 Xinggang Road, Taicang Port Economic and Technological Development Zone, Jiangsu, China PC: 215434

Notes on usage and management of the equipment

1. Read all of the instructions in the user guide before your operation. Give particular attention to all safety precautions.
2. Only a physician or a legally certified operator should use this product.
3. The equipment should be maintained in a safe and operable condition by maintenance personnel.
4. Use only computers and image display monitors complying with IEC 60601-1 or IEC 60950-1. For details, consult our sales representative or local iRay dealer.
5. Use only the dedicated cables. Do not use any cables other than those supplied with this product.
6. Request your sales representative or local iRay dealer to install this product.

Caring for your environment



This symbol indicates that this product is not to be disposed of with your residential or commercial waste.

Recycling iRay Equipment

Please do not dispose of this product with your residential or commercial waste. Improper handling of this type of waste could have a negative impact on health and on the environment. Some countries or regions, such as the European Union, have set up systems to collect and recycle electrical or electronic waste items. Contact your local authorities for information about practices established in your region. If collection systems are not available, call iRay Customer Service for assistance.

Disclaimer

iRay shall not be liable to the purchaser of this product or third parties for any damage, loss, or injury incurred by purchaser or third parties as a result of fire, earthquake, any accident, misuse or abuse of this product.

iRay shall not be liable to any damage, loss, or injury arising from unauthorized modifications, repairs, or alterations to this product or failure to strictly comply with iRay' s operating and maintenance instructions.

iRay shall not be liable for any damage or loss arising from the use of any options or consumable products other than those dedicated as Original iRay Products by iRay Technology.

It is the responsibilities of the user/attending physicians for maintaining the privacy of image data and providing medical care services. iRay shall not be responsible for the legality of image processing , reading and storage nor it shall be responsible for loss of image data for any reason.

Information regarding specification, compositions, and appearance of this product is subject to change without prior notice. .

Copyright

All rights reserved







No part of this publication may be reproduced in any form or by any means without the written permission of iRay. The information contained herein is designed only for use with iRay Mars1717V (configuration: Mars1717V3)

Trademarks

The iRay name and iRay logo are registered trademarks of iRay Technology Co.Ltd.









Symbols and Conventions







The following symbols and conventions are used throughout the user guide.

	This symbol is used to identify conditions under which improper use of the product may cause death or serious personal injury.
	This notice is used to identify conditions under which improper use of the product may cause minor personal injury.
	This notice is used to identify conditions under which improper use of the product may cause property damage.
	This is used to indicate a prohibited operation.
	This is used to indicate an action that must be performed.
	This is used to indicate important operations and restrictions.
	This is used to indicate operations for reference and complementary information.

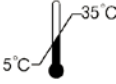
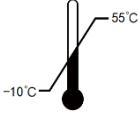
Labels and markings on the equipment

The contents of the labels and markings on iRay Mar1717V product are indicated below:

Symbol	Guide
	Caution: please refer to the instructions in the user manual.
	This symbol is used to indicate that the equipment has passed CE testing and it is followed by the CE number.
	<p>This symbol is used to identify the manufacturer's series number which is after, below or adjacent to the symbol. The series number of iRay products is usually made of thirteen digits as shown below:</p> <p style="text-align: center;"> <u>A1A2A3A4</u> <u>C1C2</u> <u>M</u> <u>DD</u> <u>Y</u> <u>XXX</u> </p> <div style="display: flex; justify-content: space-around; align-items: center;"> <div style="border-left: 1px solid black; border-right: 1px solid black; width: 100px; height: 100px; margin: 0 auto;"></div> <div style="text-align: right;"> <p>Numerical Order</p> <p>Year</p> <p>Date</p> <p>Month</p> <p>Version</p> <p>Product Code</p> </div> </div>
	This symbol is used to indicate the name and address of the manufacturer.
	This symbol is used to indicate the name and address of iRay authorized representative in the European region.
	This symbol is used to indicate consultation of the user guide for general information.
	Safety Signs: please refer to the user guide for safety instructions.
	Safety Signs: Dangerous Voltage.
	Stand-by.

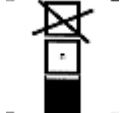
	<p>Handled with care.</p>
	<p>This symbol is used to indicate the operational temperature limits.</p>
	<p>This symbol is used to indicate the storage temperature limits.</p>
	<p>Package symbol, fragile.</p>
	<p>Package symbol, keep away from sunlight.</p>
	<p>Package symbol, keep dry.</p>
	<p>Package symbol, this symbol is used to indicate the humidity limits.</p>
	<p>Package symbol, keep the equipment up right.</p>
	<p>Package symbol, do not roll the transportation package.</p>
	<p>Package symbol, this symbol is used to indicate stacking limit number.</p>

TO CUSTOMERS.....	2
CONTENTS.....	7
1. SAFETY	9
1.1 Safety precautions.....	10
1.2 Notes for Using of FPD.....	15
1.3 Notes for Using of Battery	15
2. GENERAL DESCRIPTION	17
2.1 Scope.....	18
2.2 Model.....	18
2.3 Characteristic.....	19
2.4 INTENDED USE	19
2.5 ESSENTIAL PERFORMANCE.....	19
2.6 Application specification	19
2.7 The relative position between patient and detector.....	20
2.8 Product Components.....	21
2.9 Components Description and Specification.....	24
2.9.1 <i>Detector</i>	24
2.9.2 <i>Battery</i>	27
2.9.3 <i>Battery Charger</i>	30
2.9.4 <i>Power supply</i>	34
2.9.5 <i>Recommended Application Condition</i>	34
2.9.6 <i>Use Environment</i>	35
3. INSTALLATION	36
3.1 Panel Installation	37
3.1.1 <i>Attach Battery Pack</i>	37
3.1.2 <i>Attach DC Power</i>	38
3.1.3 <i>Booting Up</i>	38
3.1.4 <i>Indicator</i>	38
3.1.5 <i>Button function table</i>	41
3.2 Battery Charger Installation	42
4. SOFTWARE SETUP.....	43
4.1 System requirement	44
4.2 Environment setup.....	44
4.3 Connetion Mode	44
4.4 Wired Connection Setup (Service Only).....	45
4.5 Wireless AP Mode Connection.....	46
4.6 Wireless Client Mode Conneciton	56
4.7 iDetector software.....	64





4.7.1	HomePage.....	65
4.7.2	Acquire Page.....	66
4.7.3	Detector Page.....	68
4.7.4	Calibrate Page.....	68
4.7.5	Local Page.....	68
4.8	List of the HAZARDOUS SITUATIONS resulting from a failure of the IT-NETWORK.....	69
5.	OPERATION	70
5.1	Main Operation	71
5.1.1	Steps for acquiring image.....	72
5.1.2	Software Mode.....	73
5.1.3	Inner Mode.....	76
5.1.4	FreeSync Mode	79
5.1.5	After Use.....	80
5.2	Correction and Calibration Template Generation.....	81
5.2.1	HW pre-offset Template Generation.....	81
5.2.2	Gain Calibration Template Generation.....	82
5.2.3	Defect Correction Template Generation.....	83
5.3	Local Image Check.....	85
5.4	Firmware Upgrade.....	87
5.5	Shock sensor.....	89
6.	REGULATORY INFORMATION.....	92
6.1	Medical equipment safety standards.....	93
6.2	Guidance and manufacture's declaration for EMC	95
6.2.1	EMI Compliance Table	95
6.2.2	EMS Compliance Table.....	95
6.3	Radio Frequency Compliance Information.....	98
6.3.1	FCC Compliance	99
6.4	Battery Safety Standards.....	99
7.	TROUBLE SHOOTING.....	101
8.	SERVICE INFORMATION	102
8.1	Service Office Info	103
8.2	Product Lifetime.....	103
8.3	Regular Inspection and Maintenance.....	103
8.4	Repair	103
8.5	Replacement Parts Support	103
	Appendix A Information of Manufactures	106



1. Safety



1.1 Safety precautions	10
1.2 Notes for Using.....	15

1.1 Safety precautions

Follow these safeguards and properly use the equipment to prevent injury and damage to any equipment/data.

WARNING	
<p>Installation and environment of use</p>  Prohibited  Prohibited	<ul style="list-style-type: none"> • Do not use or store the equipment near flammable chemicals such as alcohol, thinner, benzene, etc. If chemicals are spilled or evaporate, it may result in fire or electric shock through contact with electric parts inside the equipment. Also, some disinfectants are flammable. Be sure to take care when using them. • Do not connect the equipment with anything other than specified. Doing so may result in fire or electric shock. • All the patients with active implantable medical devices should be kept away from the equipment.
<p>Power supply</p>  Prohibited	<ul style="list-style-type: none"> • Do not operate the equipment using any type of power supply other than the one indicated on the rating label. Otherwise, it may result in fire or electric shock. • Do not handle the equipment with wet hands. You may experience electric shock that could result in death or serious injury. • Do not place heavy object such as medical equipment on cables and cords. Do not pull, bend, bundle, or step on them to prevent their sheath from being damaged, and do not alter them neither. Doing so may damage the cords which could result in fire or electric shock. • Do not supply power to more than one piece of equipment using the same AC outlet. Doing so may result in fire or electric shock. • Do not turn ON the system power when condensation has formed on the equipment. Doing so may result in fire or electric shock. • Do not connect a multiple portable socket-outlet or extension cord to the system. Doing so may result in fire or electric shock. • To avoid the risk of electric shock, this equipment must only be connected to power supply with protective earth. Not doing so may result in fire or electric shock.
	<ul style="list-style-type: none"> • Securely plug the power cord into the AC outlet. If contact failure occurs, or if metal objects come into contact with the exposed metal prongs of the plug, fire or electric shock may result. • Be sure to turn OFF the power to each piece of equipment before connecting or disconnecting the cords. Otherwise, you may get an electric shock that could result in death or serious injury. • Be sure to hold the plug or connector to disconnect the cord.

	<p>If you pull the cord, the core wire may be damaged, resulting in fire or electric shock.</p>
WARNING	
<p>Handling</p>  <p>Prohibited</p>	<ul style="list-style-type: none"> • Never disassemble or modify the equipment. No modification of this equipment is allowed. Parts of the Mar1717V that are not serviced or maintained while in use with the patient. Doing so may result in fire or electric shock. Also, since the equipment incorporates parts that may cause electric shock as well as other hazardous parts, touching them may cause death or serious injury. • Do not place anything on top of the equipment. The object may fall and cause an injury. Also, if metal objects such as needles or clips fall into the equipment, or if liquid is spilled, it may result in fire or electric shock. • Do not hit or drop the equipment. The equipment may be damaged if it receives a strong jolt, which may result in fire or electric shock if the equipment is used without being repaired. • Do not put the equipment and pointed objects together. The equipment may be damaged. If so, the equipment should be used in bucky.
	<ul style="list-style-type: none"> • Have the patient take a fixed posture and do not let the patient touch parts unnecessarily. If the patient touches connectors or switches, it may result in electric shock or malfunction of the equipment.
<p>When a problem occurs</p>	<ul style="list-style-type: none"> • Should any of the following occurs, immediately unplug the power cord of Control Box, and contact your sales representative or local iRay dealer: When there is smoke, an odd smell or abnormal sound. When liquid has been spilled into the equipment or a metal object has entered through an opening. When the equipment has been dropped and damaged.
<p>Maintenance and inspection</p>  <p>Prohibited</p>	<ul style="list-style-type: none"> • Please turn OFF the power of the equipment and unplug the power cord of adaptor before cleaning. • NEVER use alcohol, ether and other flammable cleaning agent for safety. NEVER use methanol, benzene, acid and base because they will erode the equipment. • DON'T dip the equipment into the liquid. • Please make sure that the equipment's surface & plugs are dry before turning ON. Otherwise, it may result in fire or electric shock.

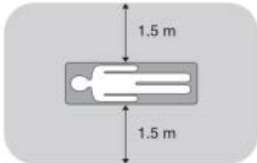
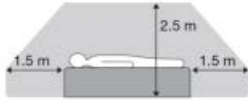
	<ul style="list-style-type: none"> • Clean the plug of the power cord periodically by unplugging it from the AC outlet and removing dust or dirt from the plug, its periphery and AC outlet with a dry cloth. If the cord is kept plugged in for a long time in a dusty, humid or sooty place, dust around the plug will attract moisture; this could cause insulation failure that may result in a fire. • For safety reasons, be sure to turn OFF the power to each piece of equipment when performing inspections indicated in this manual. Otherwise, electric shocks may occur.
CAUTION	
<p>Installation and environment of use</p> 	<ul style="list-style-type: none"> • Do not install the equipment in any of the locations listed below. Doing so may result in failure, malfunction, equipment falling, fire or injury. Close to facilities where water is used Where it will be exposed to direct sunlight Close to the air outlet of an air-conditioner or ventilation equipment Close to heat source such as a heater Where the power supply is unstable In a dusty environment In a saline or sulfurous environment Where temperature or humidity is high Where there is freezing or condensation In areas prone to vibration On an incline or in an unstable area • Take care that cables do not become tangled during use. Also, be careful not to get your feet caught by cable. Otherwise, it may cause a malfunction of the equipment or injury of the user due to tripping over the cable. <div style="display: flex; justify-content: space-around; align-items: center;">   </div>
<p>Power supply</p>	<ul style="list-style-type: none"> • Always connect the three-core power cord plug to a grounded AC power outlet. • To make it easy to disconnect the plug at any time, avoid putting any obstacles near the outlet. Otherwise, it may not be possible to disconnect the plug in an emergency. • Be sure to ground the equipment to an indoor grounded connector. Also, be sure to connect all the grounds for the system to a common ground. • Do not use any power source other than the one provided with this equipment. Otherwise, fire or electric shock may be caused due to leakage.

<p>Handling</p>	<ul style="list-style-type: none"> • Do not spill liquid or chemicals onto the equipment. In case the patient is injured, it is not allowed to contact with blood or other body fluids. Doing so may result in fire or electric shock. In such a situation, protect the equipment with a disposable cover as necessary. • Turn OFF the power and pull out the plug to each piece of equipment for safety when not used.
------------------------	---

CAUTION

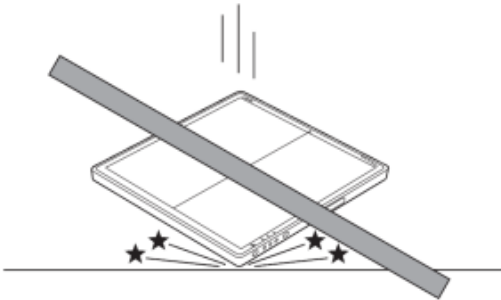
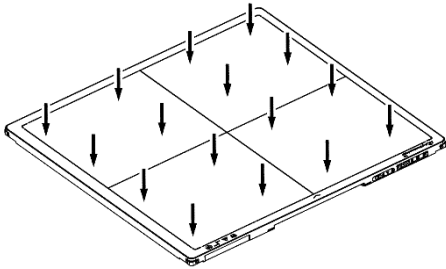
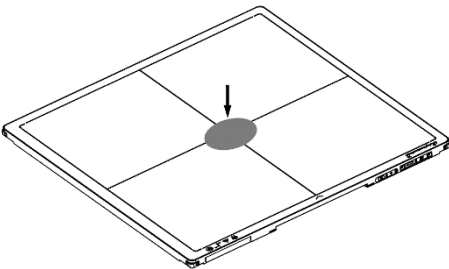
<p>Handling</p> 	<ul style="list-style-type: none"> • Handle the equipment carefully. • Do not submerge the equipment in water. • The internal image sensor may be damaged if something hits against it or it is dropped. • Do not place excessive weight on the equipment.  <ul style="list-style-type: none"> • Otherwise, the internal image sensor may be damaged and image may be incorrect. • • <Load Limit> • Uniform load: 150 kg over the whole area of the detector surface.  <ul style="list-style-type: none"> • Local load: 135 kg on an area 4 cm diameter.  <ul style="list-style-type: none"> • Be sure to use the equipment on a protected foam. Otherwise, the internal image sensor may be damaged.
--	--

Be sure to securely hold the detector while using it in upright positions. Otherwise, the detector may fall over, resulting in injury to the user or patient, or may flip over, resulting in damage to the inner device.

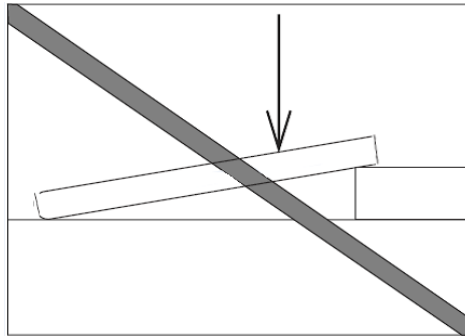

Keep the same load (same pressure) on the detector when acquiring the image. Otherwise, the image will be incorrect.

CAUTION



CAUTION

- Do not close to fire, do not use in high temperature
- Do not invert positive and negative pole
- Do not contact with metal in case of short circuit
- Do not insert sharp objects into battery
- Do not beat battery
- Do not stand on battery
- Do not use battery out of rules
- Do not dispose battery or change internal structure
- Do not submerge battery in water, please keep dry in storage and do not contact with water in use
- Please charge battery with charger following IEC60601-1 & IEC62133 Standards provide by us
- Do not mix battery with ones not provided by our company
- Do not charge battery with broken charger.

1.2 Notes for Using of FPD

When using the equipment, take the following precautions. Otherwise, problems may occur and the equipment may not function correctly.

Before exposure

- Be sure to check the equipment daily and confirm that it works properly.
- Be sure there be a battery installing on the Mars1717V to avoid the power off suddenly
- Sudden heating of the room in cold areas will cause condensation to form on the equipment. In this case, wait until the condensation evaporates before performing an exposure. If the equipment is used while condensation is formed on it, problems may occur in the quality of captured images. When an air-conditioner is used, be sure to raise/lower the temperature gradually so that a difference of temperature in the room and equipment does not occur, to prevent condensation.
- The detector should warm up for 15 minutes before exposure or updating the gain map or defect map.

During exposure

- Do not move the power during exposure, or it may cause image noise or artifacts, even incorrect images.
- Do not use the devices near the equipment generating a strong magnetic field. Otherwise, it may cause image noise, artifacts or even incorrect images.
- Do not prep twice continuously when the exposure window is opening, it may cause it may cause image row noise, column noise even incorrect images.

Disinfection and Cleaning (When in portable usage)

- After every examination, wipe the patient contact surfaces of the detector using disinfectants such as ethanol, to prevent the risk of infection. For details on how to sterilize, consult a specialist.
- Do not spray the detector directly with disinfectants or detergents.
- Wipe it with a cloth slightly damped with a neutral detergent. Do not use solvents such as alcohol, thinner, benzene, acid and base. Doing so may damage the surface of the equipment.
- It's recommended to use a waterproof non-woven cover as the isolated layer between detector and the bleeding patient.

1.3 Notes for Using of Battery

-
- Battery is shipped with detector, remaining capacity should be charged greater than or equal to 50% but less than 60%. If storage without use, charge greater than or equal to 50% but less than 60% every 3 month, or it causes damage to battery.
 - Battery is shipped in package without detector, remaining capacity should be charged greater than or equal to 20% but less than 30%, If storage without use, charge greater than or equal to 20% but less than 30% every 2 month, or it causes damage to battery.

If battery remaining capacity is lower than 20%, delivery is not allowed, or it is possible to be over discharge.

Battery storage and working environment should strictly follow specification. If there is any objection, there is possibility to damage performance

If battery is not used in detector, please detach it.

2. General Description

2.1 Scope.....	18
2.2 Model.....	18
2.3 Characteristic.....	19
2.4 INTENDED USE	19
2.5 ESSENTIAL PERFORMANCE.....	19
2.6 Application specification	19
2.7 The relative position between patient and detector.....	20
2.8 Product Components.....	21
2.9 Components Description and Specification.....	24
2.9.1 <i>Detector</i>	24
2.9.2 <i>Battery</i>	27
2.9.3 <i>Battery Charger</i>	30
2.9.4 <i>Power supply</i>	34
2.9.5 <i>Recommended Application Condition</i>	34
2.9.6 <i>Use Environment</i>	35

Mars1717V (configuration : Mars1717V3, hereinafter referred as Mars1717V) is a cassette-size wireless X-ray flat panel detector based on amorphous silicon thin-film transistor technologies. It is developed to provide the good quality of radiographic image, which contains an active matrix of 3072×3072 with 139um pixel pitch. Panels' scintinator is CsI (Cesium Iodide). Mars1717V supports wireless communication between panel and Workstation, and can be used as a real portable panel.

2.1 Scope

This manual contains information about the Mars1717V. Information in the manual, including the illustrations, is based on prototype. If your configuration does not have any of these items, information about these items does not apply to your panel.

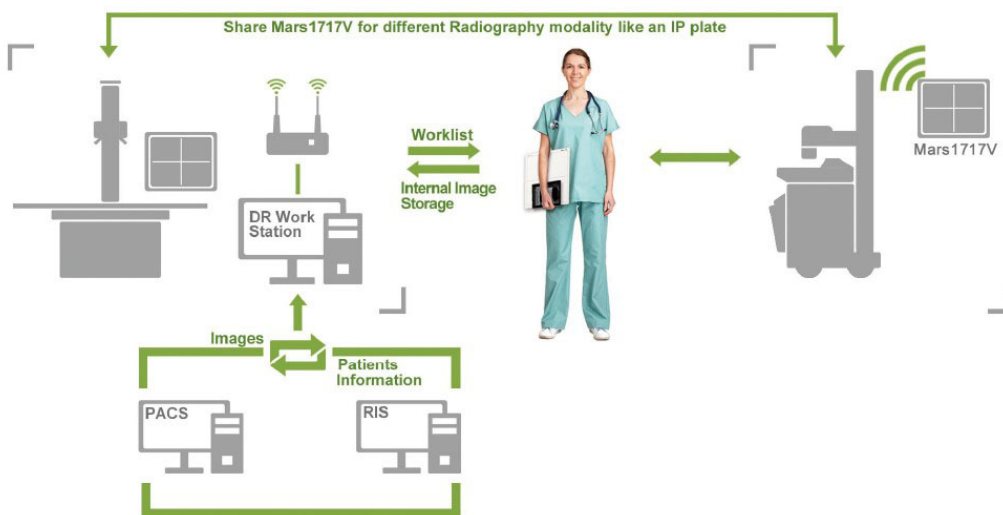

2.2 Model

Mars 1717 V - VSI

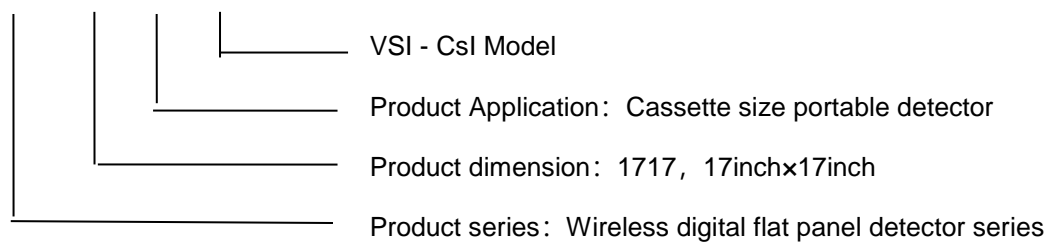

Product Type: Battery - KV-----Rechargeable lithium battery

Product Type: Charger - KV-----Battery charger

2.3 Characteristic

- Wireless static flat panel detector used for general radiography.
- Cassette-size
- Sync-shot exposure trigger
- CsI scintillation screen.
- Easy to upgrade firmware.
- Battery recycling
- 16-bit AD

2.4 INTENDED USE

Mars1717V Wireless Digital Flat Panel Detector is indicated for digital imaging solution designed for providing general radiographic diagnosis of human anatomy. It is intended to replace radiographic film/screen systems in all general-purpose diagnostic procedures. This panel provides digital X-ray imaging for diagnosis of disease, injury, or any applicable health problem. The image is obtained as the result of X-ray passing through the human body and detected by detector.

iRay would provide hardware and software support for integration of system.

This panel is not intended for mammography or dental applications.

2.5 ESSENTIAL PERFORMANCE

According to the Mars1717V series INTENDED USE and the result of risk management, image acquisition and data transmission are defined as ESSENTIAL PERFORMANCE.

Getting dark image proves that ESSENTIAL PERFORMANCE does not influence INTENDED USE. Method for getting dark image in detail refers to section “installation” and “operation”

2.6 Application specification

PATIENT population:

Age: except for children

Weight: not relevant

Health: not relevant

Nationality: multiple

Gender: except for pregnant women

Intended OPERATOR:

All of use, maintenance and operation steps should be carried out by the operator who has accepted the professional training offered by the company's customer service staff.

Life-time:

Life-time: 5 years without frequency limit



2.7 The relative position between patient and detector

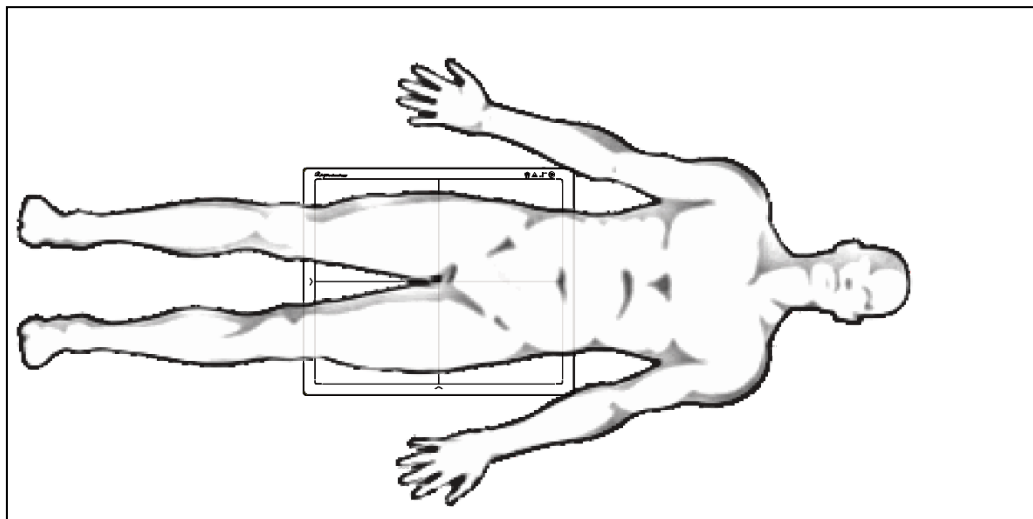



Because of the crosstalk effect of Amorphous silicon flat-panel detector, Pay attention to the relative position of patient and detector, the recommended position as shown below, Otherwise, the image is prone to abnormal light lines.



2.8 Product Components

Mars1717V comes with both DC power supply and battery package. Once powered on, it would build a connection with Workstation through Ethernet cable (only for service) or Wireless connection.

	Item	Description
Mars1717V Detector	 The image shows the Mars1717V Detector main unit, which is a black rectangular device with a screen displaying a grid and some text. The screen is divided into four quadrants by a white crosshair. The word "UNIVERSALOR" is visible at the top left of the screen.	1 pcs Main Unit
Medical Adapter for <ul style="list-style-type: none">● Detector and● Battery Charger	 The image shows a black medical adapter with several cables attached. One cable is a power cord, and another is a connector cable with a circular plug.	1 pcs DC 24V
Battery	 The image shows a white, rectangular battery pack with a hinged lid.	2 pcs Battery pack

<p>Ethernet Cable (Only for service)</p>		<p>1pcs 3.5 m</p>
<p>Gigabit Ethernet Cable</p>		<p>1pcs 3 m</p>
<p>AC Power Cable</p>		<p>1 pcs</p>
<p>DC Power Cable</p>		<p>1 pcs 3.5 m</p>
<p>Battery Charger</p>		<p>1pcs</p>

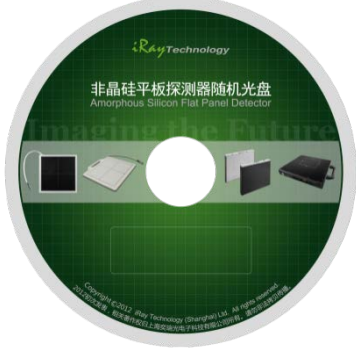
CD-Rom		1pcs
--------	--	------

2.9 Components Description and Specification

2.9.1 Detector

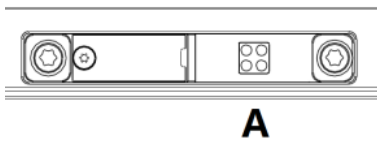
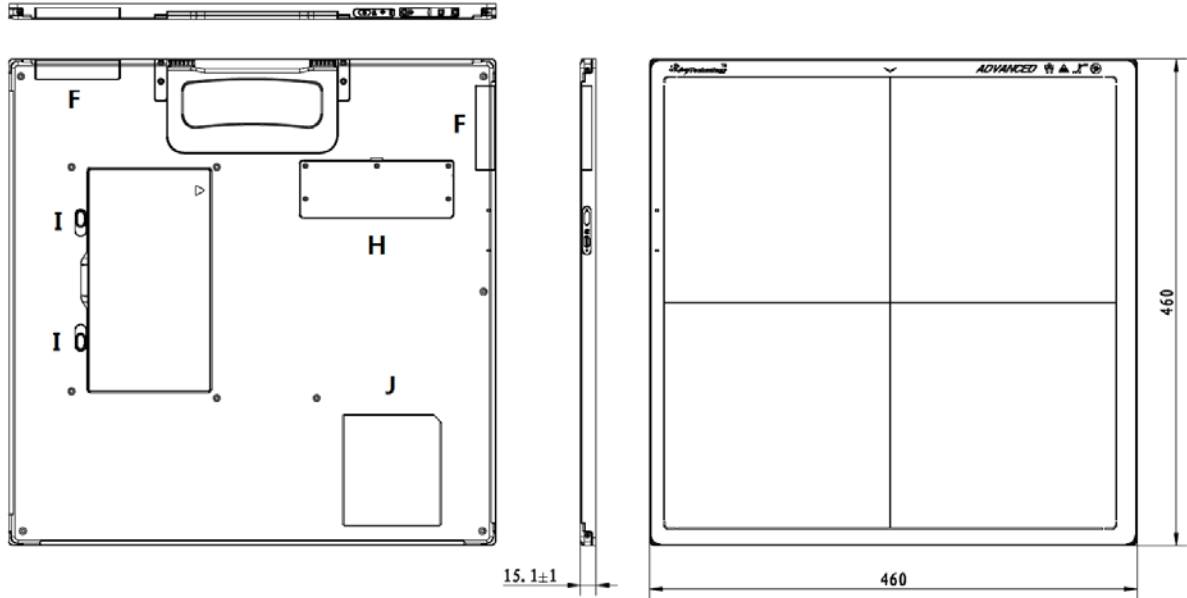

A
External Signals Input

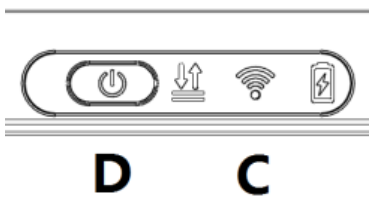

C
D
Control Panels

Item	Name	Description
------	------	-------------

A	DC Jack	24V DC input
B	Mode Key	Change the work mode of Panel, refer to 3.1.5
C	Detector Indicator	Detector indicator of control panel
D	Power Button	Power button of control panel
F	Antenna	Antenna
H	Maintenance Cover	For service engineer to maintenance
I	Battery Lock	The lock button for detaching battery
J	Detector Label	Product information.

Detector Specification

Item	Specification
Model	Mars1717V-VSI (Csl)
Image Sensor	a-Si (Amorphous Silicon) TFT
Pixel Size	139 μ m
Effective Array	3072 x 3072
Effective Area (H x V)	427mm x 427mm
Gray scales	16bit
Limiting Spatial Resolution	3.6 Lp/mm without phantom or grid
Image Acquisition Time (Wireless)	Preview Acquisition Time: 3 sec.
Client mode(5G)	Processed Acquisition Time : 5 sec. (including Preview Time)
Cycle Time	Min. 8s
Power Consumption	Max. 20W
Dimension (L x W x H)	460 x 460 x 15 mm
Weight (with one battery)	Mars1717V-VSI: \leq 4.6 kg
Image Transfer	Wireless : IEEE802.11 a/b/g/n/ac
Wireless Frequency Range	2.412~2.472GHz, 5.18~5.22GHz; 5.745~5.85GHz
Data Transmission Power	13dBm (Typ.) @802.11a 16dBm (Typ.) @802.11b

	14dBm (Typ.) @802.11g 13dBm (Typ.) @802.11n HT20 11dBm (Typ.) @802.11n HT40 16dBm@2.4GHz 13dBm@5.8GHz
Wireless Modulation	11b: DSSS (DBPSK, DQPSK and CCK) 11a/g/n: OFDM (BPSK, QPSK, 16QAM, 64QAM)
Wireless Band	2.4GHz≤40MHz 5.19GHz≤40MHz 5.8GHz≤40MHz
X-ray Energy	40kV to 150kV

2.9.2 Battery

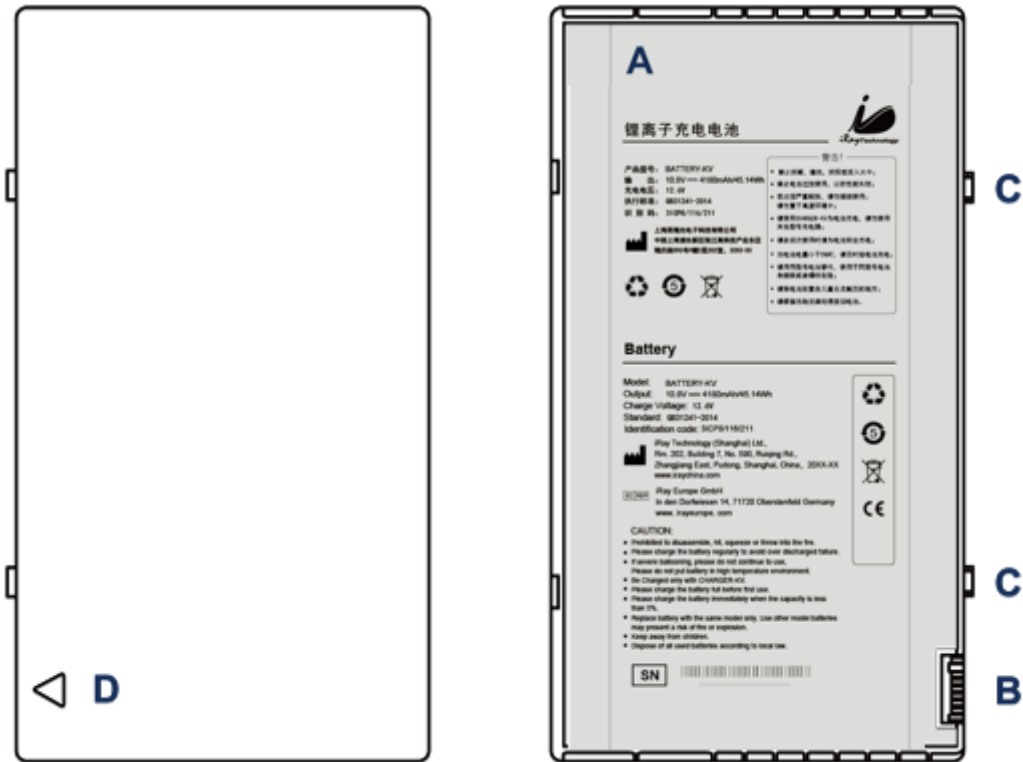

Item	Name	Description
A	Battery Label	/
B	Battery Interface	8 Pin Battery connector
C	Pilot Pin	/
D	Indicator	Installation direction indicator

Dimension and Specification

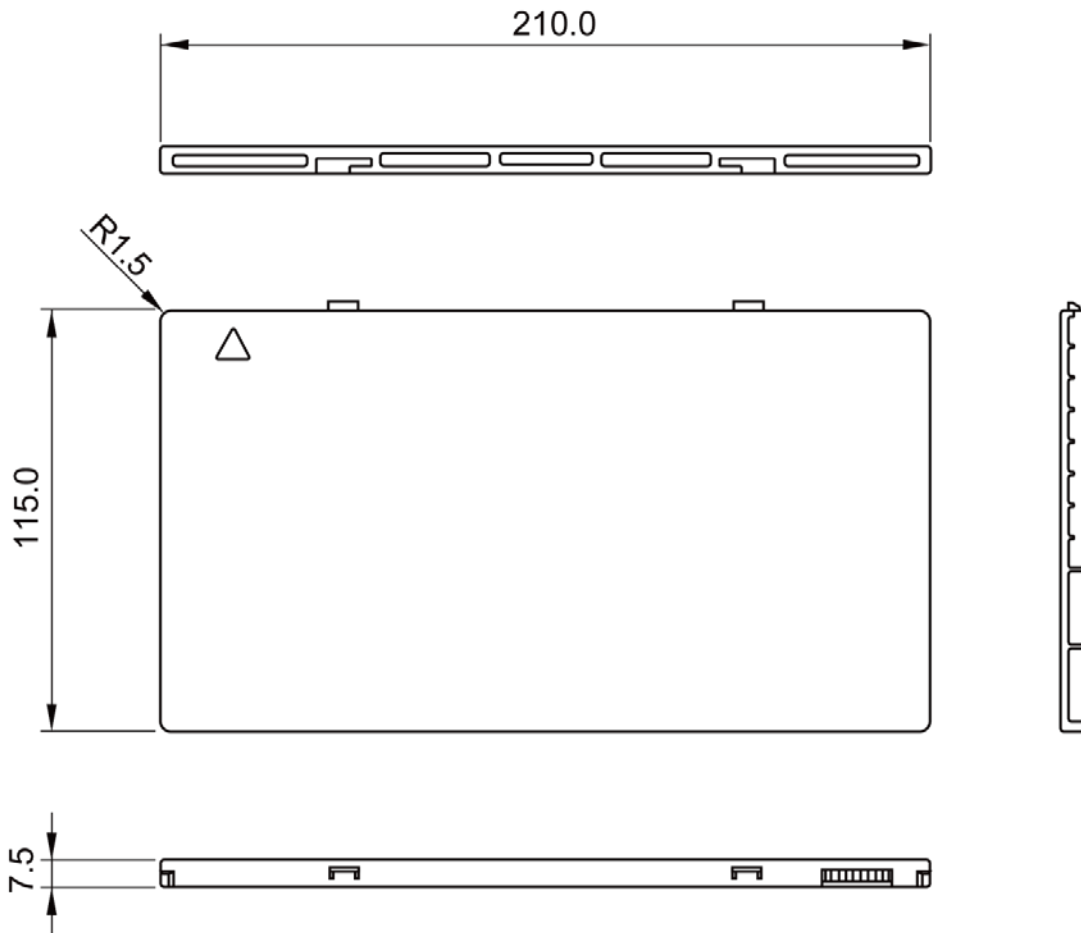

Item	Specifications
Model	Battery-KV
Rated Capacity	Min. 3950mAh, Typ. 4180mAh @ Discharge 0.2C
Nominal Voltage	10.8V
Charge Voltage	12.6±0.05V
Discharged End Voltage	8.25V
Charging Method	CC-CV
Operating Temperature	Charge 0°C-+45°C, Discharge-10°C-+40°C
Storage Temperature	1 month-20°C-+50°C
	3 month -20°C-+40°C
	6 month -20°C-+20°C

Relative Humidity	65±20%
Dimension (L × W × H)	210 x 115 x 7.5 mm
Weight	0.22kg

2.9.3 Battery Charger



Item	Name	Description
A	Battery Interface	8 Pin Battery connector
B	Capacity Indicator	The indicator definition is as follow
C	Power Indicator	The indicator definition is as follow
D	Hand Pull Position	/
E	The limit ball plug	/
F	DC Jack	24V DC input

Dimension and Specification

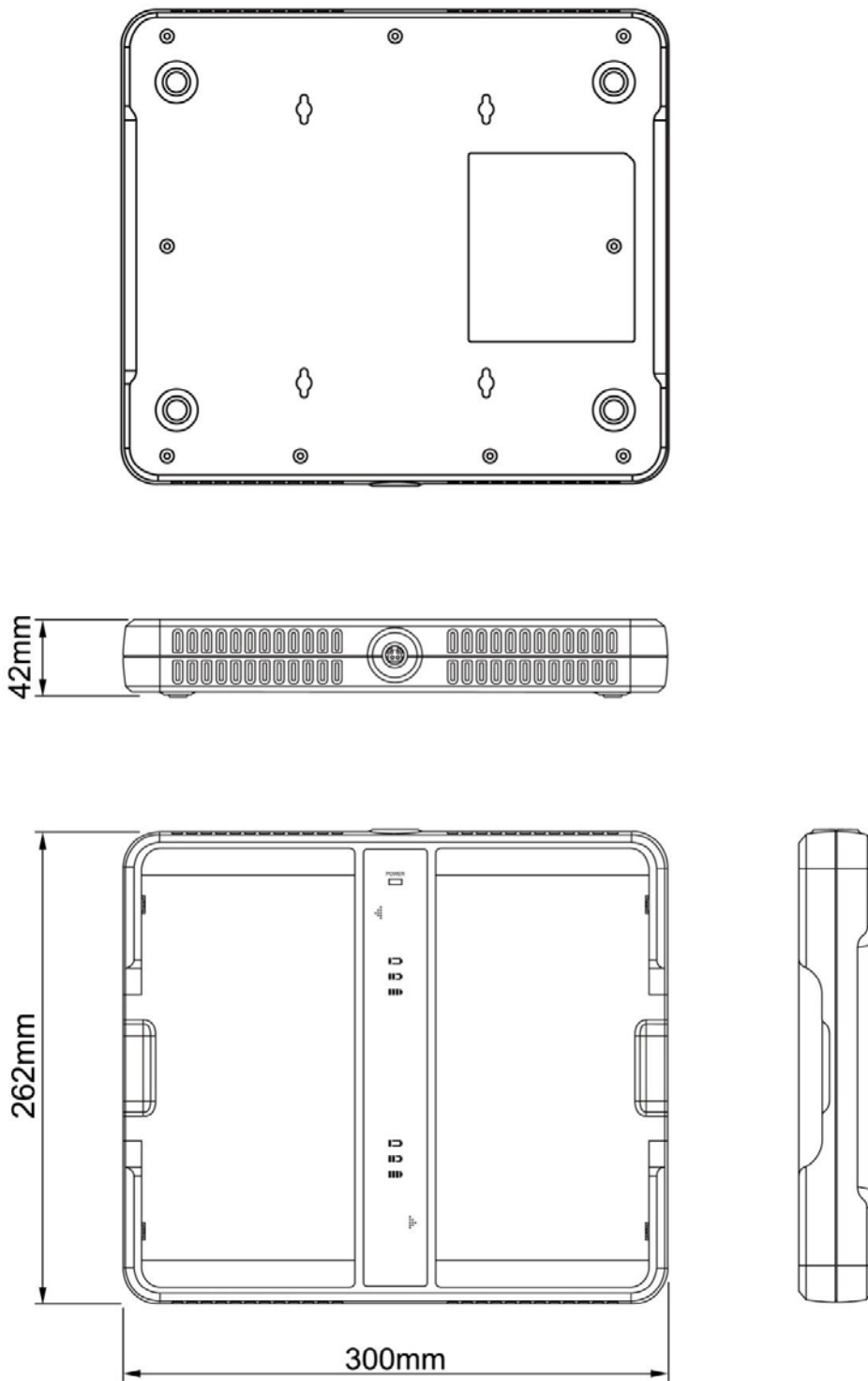

Item	Specifications
Model	Charger-KV

Simultaneous Charging	2 battery packs
Full charging time	2.5 hours
Rated power supply	24V(DC)
Dimension (L x W x H)	300 x 263 x 42 mm
Weight	1.26 kg

Firmware versions definition

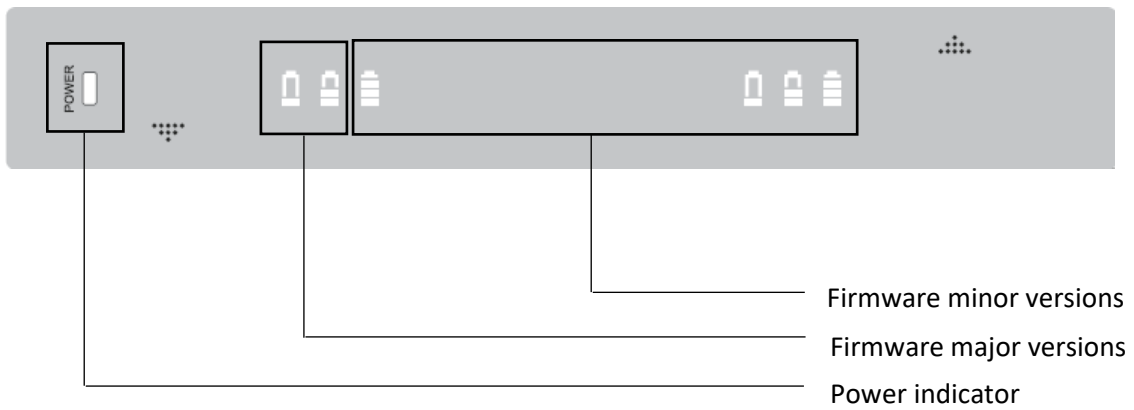





Firmware versions	Lighting Status	Value range (BCD)
Major		00-11
Minor		0000-1111

Power indicator definition:

Power Indicator	Lighting Status	Operating Status
OFF		No external DC adaptor input
GREEN		External DC adaptor input

The battery charging capacity indicator definition:

X Group Indicator	Lighting Status	Operating Status
I, II and III grid off		No battery Insert

I grid blinking II and III grid off		Battery Insert with capacity $\leq 30\%$, charging
II grid blinking I and III grid off		Battery Insert with capacity $>30\%$ and $\leq 60\%$, charging
III grid blinking I and II grid off		Battery Insert with capacity $>60\%$ and $\leq 95\%$, charging
I and II grid off III grid on		Battery Insert with capacity $>95\%$ and charging, when capacity = 100%, charging stops
I, II and III blinking		Battery enter into 2nd level protection, automatic unlock with safety condition

2.9.4 Power supply

Mars1717V supports both DC Power and Battery package input.

Item	Specifications
DC Power	24V(DC), 0.75A
Battery Package	10.8V(DC), 1.5A

2.9.5 Recommended Application Condition

Item	Description
Operating System	Windows 7 32/64bit
CPU	Intel Core i7 3.6G
Memory	4G DDR3
Hard Disk	640 G
LAN Card	Intel Pro EXP9301CT PRO Gigabit Network Adapter with PCIe interface

2.9.6 Use Environment

	Temperature	Temperature change	Humidity	Atmospheric Pressure	Pressure Change
Operating	5~30°C	<1k/min	30%~75% RH	700~1060hPa	<10kp/min (1kp=1.0197E-5Pa)
Storage	-10~40°C	<1k/min	10%~90% RH	700~1060hPa	<10kp/min (1kp=1.0197E-5Pa)

The Mars1717V serial detectors shall operate at an altitude specified not more than 3000m, the environment is only for detector.

3. Installation

3.1	Panel Installation	37
3.1.1	<i>Attach Battery Pack</i>	37
3.1.2	<i>Attach DC Power</i>	38
3.1.3	<i>Booting Up</i>	38
3.1.4	<i>Indicator</i>	38
3.1.5	<i>Button function table</i>	41
3.2	Battery Charger Installation	42

3.1 Panel Installation

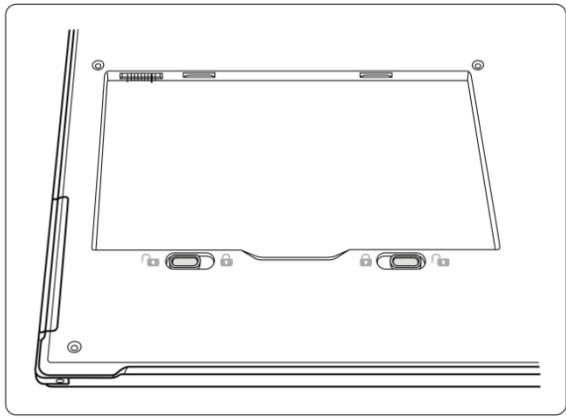
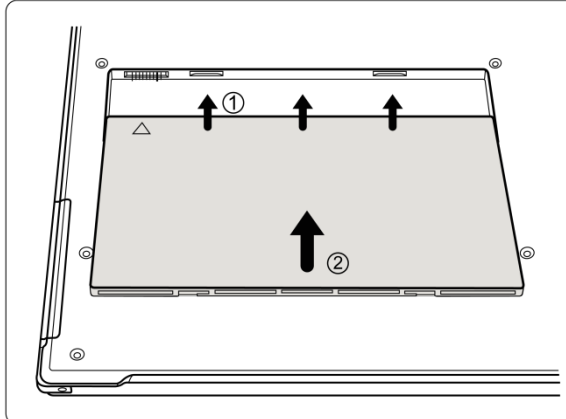
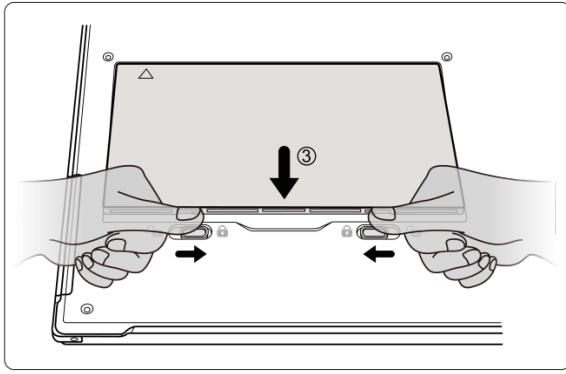

3.1.1 Attach Battery Pack

Mars1717V can be powered by both battery package and DC power. Once battery package is inserted or DC power is on, Panel would be activated immediately. If none of battery and DC power is on, Mars1717V would power off. Please see below for battery installation.

<ul style="list-style-type: none">● Make sure that the connectors on the battery package are pointed to the cave in battery compartment.	 A line drawing of the Mars1717V panel's battery compartment. The battery pack is shown being inserted into the compartment. The connectors on the battery pack are aligned with the corresponding slots in the compartment. The battery pack is shaded grey.
<ul style="list-style-type: none">● Slide battery package into battery compartment (Make sure battery capacity overpass 10%) .	 A line drawing of the Mars1717V panel's battery compartment. The battery pack is shown being pushed into the compartment. Three upward-pointing arrows labeled '1' are positioned above the battery pack, and one upward-pointing arrow labeled '2' is positioned below the battery pack, indicating the direction of insertion. The battery pack is shaded grey.
<ul style="list-style-type: none">● Slide the battery lock lever.	 A line drawing of the Mars1717V panel's battery compartment. Two hands are shown sliding the battery lock lever. A downward-pointing arrow labeled '3' is positioned above the lever, and two horizontal arrows labeled '4' are positioned below the lever, indicating the direction of movement. The battery pack is shaded grey.

3.1.2 Attach DC Power

Please see below for DC power installation.

<ul style="list-style-type: none">● Connect one end of DC Power Cable to the Medical Adapter	
<ul style="list-style-type: none">● As figure is power interface Ethernet interface	
<ul style="list-style-type: none">● Connect another end of DC Power Cable to the DC input of the detector.	

3.1.3 Booting Up

On the control panel, user can press power button to power on/off.

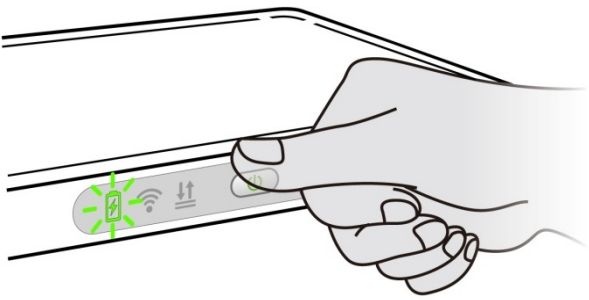
<ul style="list-style-type: none">● If panel is powered off, user can press the button for 4 seconds to power on when battery is inserted and battery capacity is no less than 10%, or DC power is connected.● If panel is powered on, user can press the button for 4 seconds to shut down. On the other hand, it can also be used as reset inner control IC when button is active for 8s.	
--	--



3.1.4 Indicator

After booting up, users can check the status indication of LED as follows.



Power Indicator	Lighting Status	Operating Status		
		Operating	Battery Capacity	DC Input
OFF		Power OFF, Not charging	/	NO
		Power OFF, Charging Finish	= 100%	YES
Green, Blinking	 	Power OFF, Battery Charging	≥95%, <100%	YES
Green, Orange, Blinking alternately	   	Power OFF, Battery Charging	≤95%	YES
Green ON		Power ON	/	YES
			≥20%	NO
Orange, Blinking	 	Power ON, Battery Low	<20%	NO
Green, Double Blinking	 	Power ON, Sleep Mode	/	/

* Panel will be power off automatically after Battery Capacity <10%.





Link indicator is as table:

Link Indicator	Lighting Status	Description
OFF		<ul style="list-style-type: none"> Power OFF No Connection
Blue ON		<ul style="list-style-type: none"> Wireless Connection is built
Green ON		<ul style="list-style-type: none"> Wired Connection is built

Mode indicator is as table:



Mode Indicator	Lighting Status	Description
OFF		<ul style="list-style-type: none"> Power OFF Wired Connection(Service only)
Green ON		<ul style="list-style-type: none"> AP Mode Connection is built
Blue ON		<ul style="list-style-type: none"> Client Mode connection is built

Status indicator is as table:

Status Indicator	Lighting Status	Description
OFF		<ul style="list-style-type: none"> Panel Power OFF Exposure Prohibited
Green ON		<ul style="list-style-type: none"> Exposure Enable
Orange ON		<ul style="list-style-type: none"> Fatal Error
Orange blinking		<ul style="list-style-type: none"> Safety Mode

3.1.5 Button function table

The Button function is shown as table below

Action	FPD Status	Power	Mode	Note
				
N.A.	/	No-Action	No-Action	
Power ON	Power OFF	Short-Hold	No-Action	Hold for 4 seconds.
Forced Restart		Long-Hold	No-Action	Hold for more than 7 seconds, Release Power Key when the POWER indicator is ON.
Forced Restart	Power ON	Long-Hold	No-Action	Hold for more than 7 seconds, when the POWER indicator is OFF and then ON, Release Power Key.
Enter/Exit Sleep Mode		Double-Click	No-Action	Release after two short presses (interval <1s)
Power OFF		Short-Hold	No-Action	Hold for 4 seconds, Release Power Key when the POWER indicator is OFF.
Wireless Connection Mode Switch		No-Action	Long-Hold and then Short click	<ul style="list-style-type: none"> ● Hold MODE key for more than 7 seconds. ● Release Mode KEY after Mode indicator blinking, and then Press again in 5 seconds. The Mode starts switching. ● Click Mode Key to switch mode, Mode indicator blinks at corresponding Colour ● Wait at intended Mode, the Mode will switch after Several secods. ● Mode indicator Blue : Client ● Mode indicator Green : AP

3.2 Battery Charger Installation

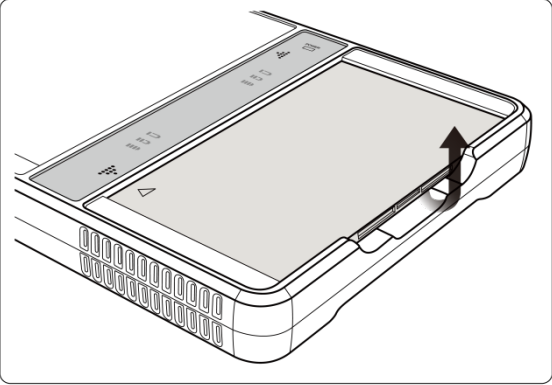
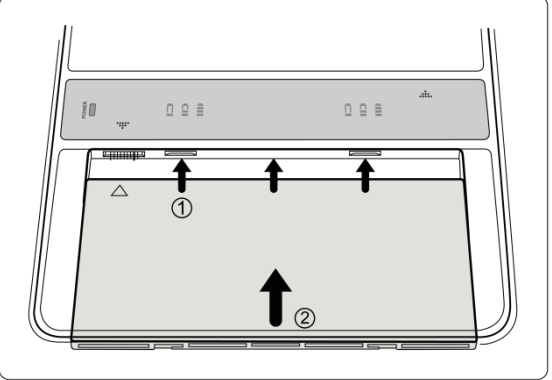
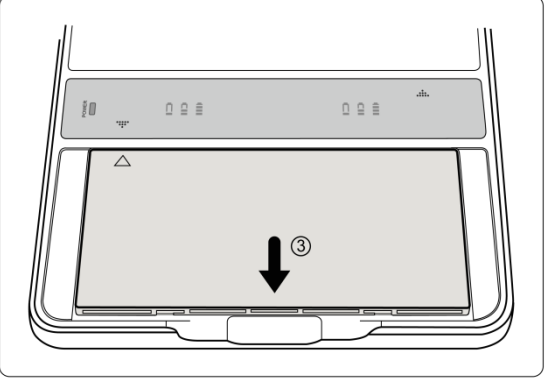
Operation	Figure
<ul style="list-style-type: none">● Unload Battery from battery charger.	 A perspective view of the battery compartment. An arrow points upwards from the battery, indicating it is being removed from the compartment.
<ul style="list-style-type: none">● Insert battery into battery charger.● Note the interface position as figure.	 A top-down view of the battery compartment. The battery is being inserted from the bottom. Three arrows labeled 1 point to the top contacts, and one arrow labeled 2 points to the bottom of the battery, indicating the insertion direction.
<ul style="list-style-type: none">● Press the battery to the bottom of battery compartment.	 A top-down view of the battery compartment. The battery is now seated in the compartment. An arrow labeled 3 points downwards from the top of the battery, indicating it should be pressed into the compartment.

4. Software Setup

4.1	SYSTEM REQUIREMENT	44
4.2	Environment setup.....	44
4.3	Connetion Mode	44
4.4	Wired Connection Setup (Service Only).....	45
4.5	Wireless AP Mode Connection.....	46
4.6	Wireless Client Mode Conneciton	56
4.7	iDetector software.....	64
4.7.1	<i>HomePage</i>	65
4.7.2	<i>Acquire Page</i>	66
4.7.3	<i>Detector Page</i>	68
4.7.4	<i>Calibrate Page</i>	68
4.7.5	<i>Local Page</i>	68
4.8	List of the HAZARDOUS SITUATIONS resulting from a failure of the IT-NETWORK.....	69

4.1 System requirement

iDetector is developed and deployed on Windows Operation System, it can be run on Windows XP/Windows 7/Windows 8/Windows 10, OS should install latest service pack. And requires computer memory 4 GB minimum. Firewall should be shut down to avoid communication issue.

4.2 Environment setup

Setup files and download url are included in Software Development Kit(hereafter refers as SDK) directory: Tools\env_setup.

1. Please install Microsoft .NET Framework 4.5(Windows XP only can install V4.0). Download from Microsoft web site, please.
2. Visual C++ redistributed package need to be installed: vcredist_x86_2013(or vcredist_x64_vs2013).
3. For Windows XP, full path should be used in file “bind.txt”.

4.3 Connection Mode

Mars1717V supports two connection modes as follows, the IP address and other information mentioned below is as the example, user should configure the connection with the specific requirement.

- 1) Wireless Client Mode

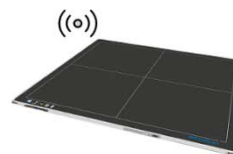
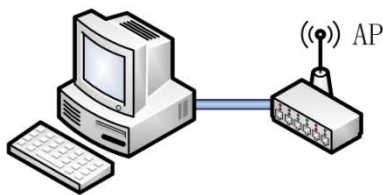

- 2) Wireless AP Mode

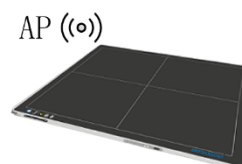
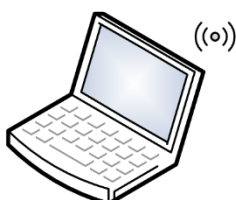

4.4 Wired Connection Setup (Service Only)

- Select wired network adapter that connected to the detector.

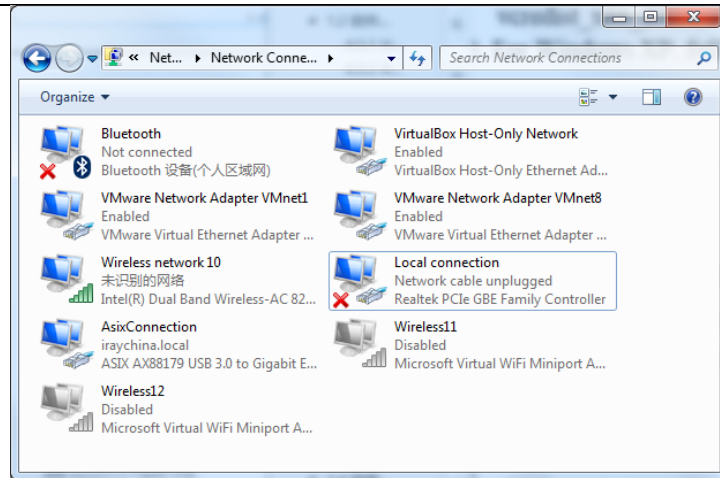

- Right click the network adapter. Then select properties.

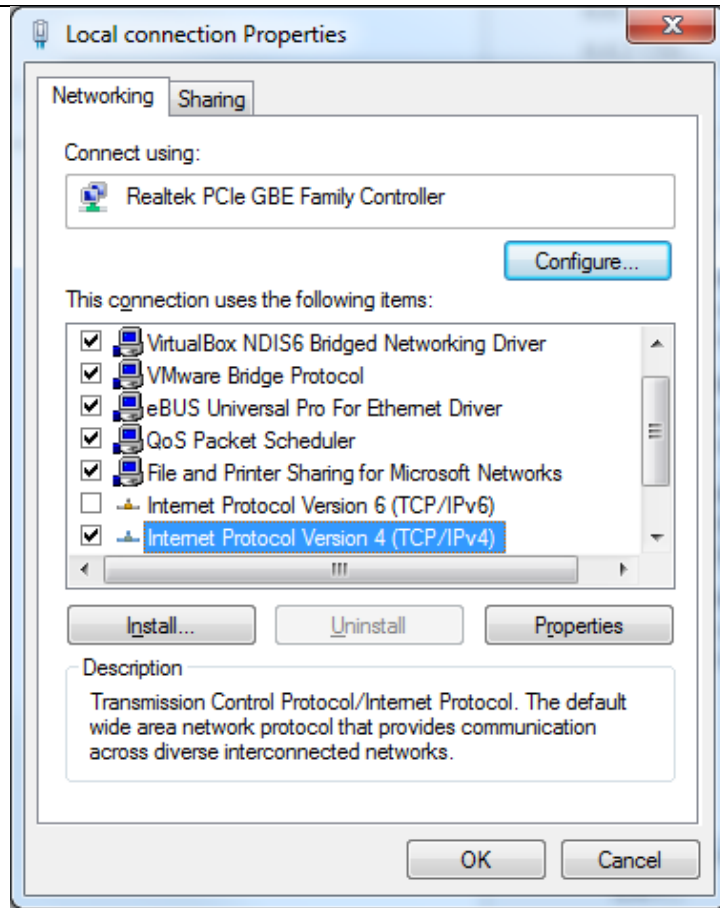

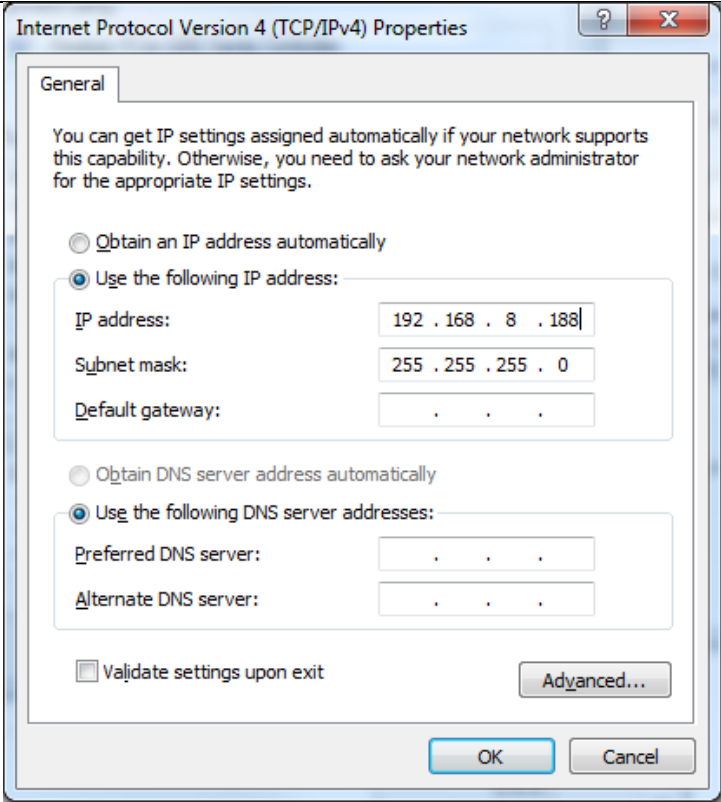
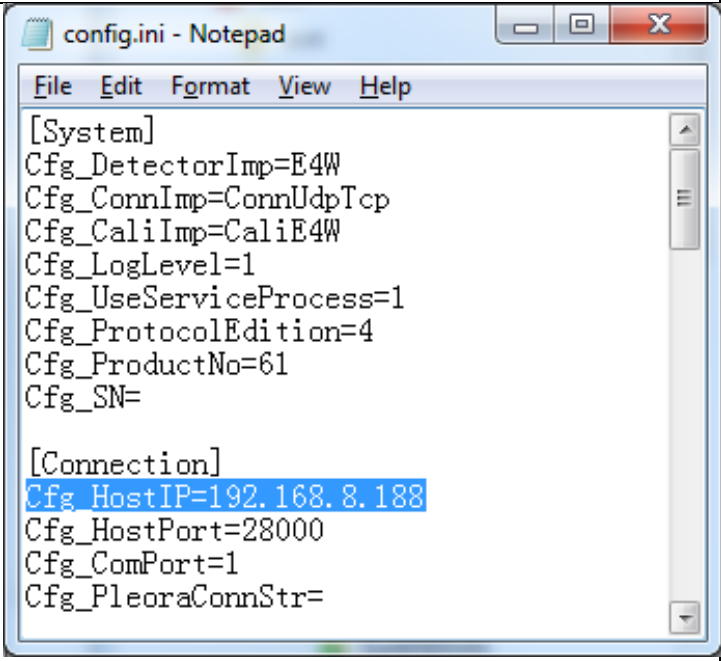
<ul style="list-style-type: none"> ● Double click IPV4 item ● Default IP settings: ● IP address : 192.168.8.188 ● Subnet mask : 255.255.255.0 	
<ul style="list-style-type: none"> ● The IP address should be identical with Cfg_HostIP item in work_dir\Mar1717V3 \config.ini file. 	

4.5 Wireless AP Mode Connection

To complete wireless connection configuration, user has to finish actions listed below.

4.5.1 Get Start with Default AP setting

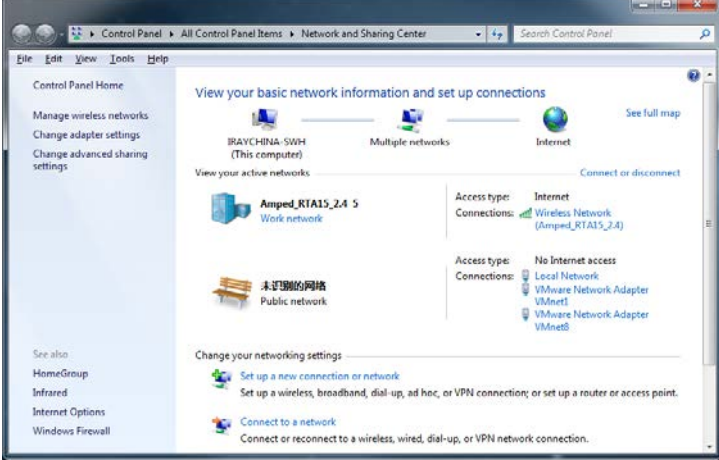
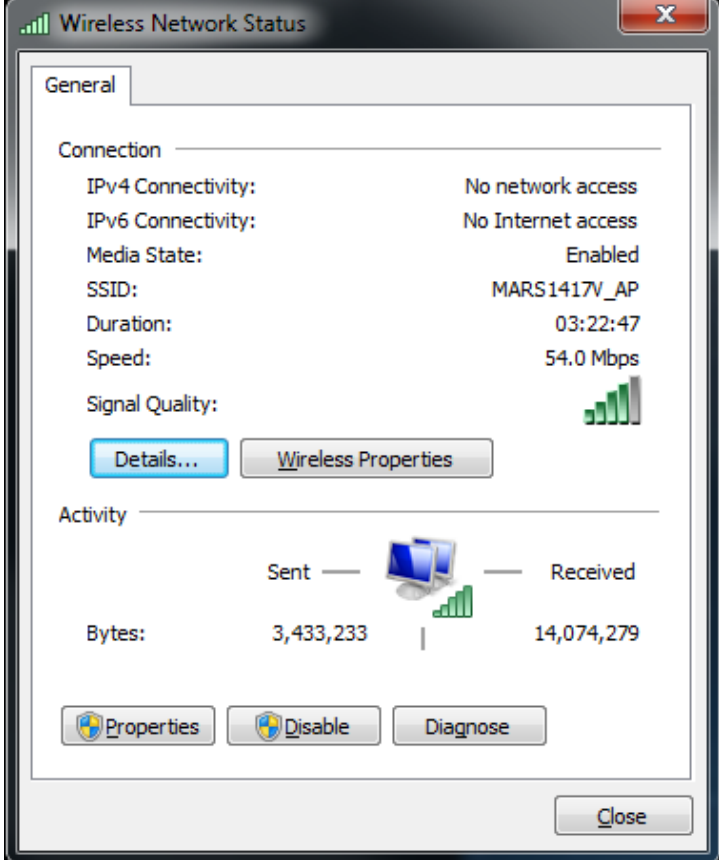
<ul style="list-style-type: none"> ● The Mars1717V detector allows user to get start with Default AP setting ● User could config the panel with default setting as follows 	
<ul style="list-style-type: none"> ● Set the Panel to AP mode, as the 3.1.5 Mode key discription ● Setup the Workstation IP address ● Open local network management interface 	
<ul style="list-style-type: none"> ● Right click the wireless adapter, select properties and entered the Wireless Connection Properties window as shown left. ● Double click IPV4 item 	

- Set the wireless adaptor IP as follows
- IP address:
192.168.8.188
- Subnet mask:
255.255.255.0
- Click OK to confirm the settings

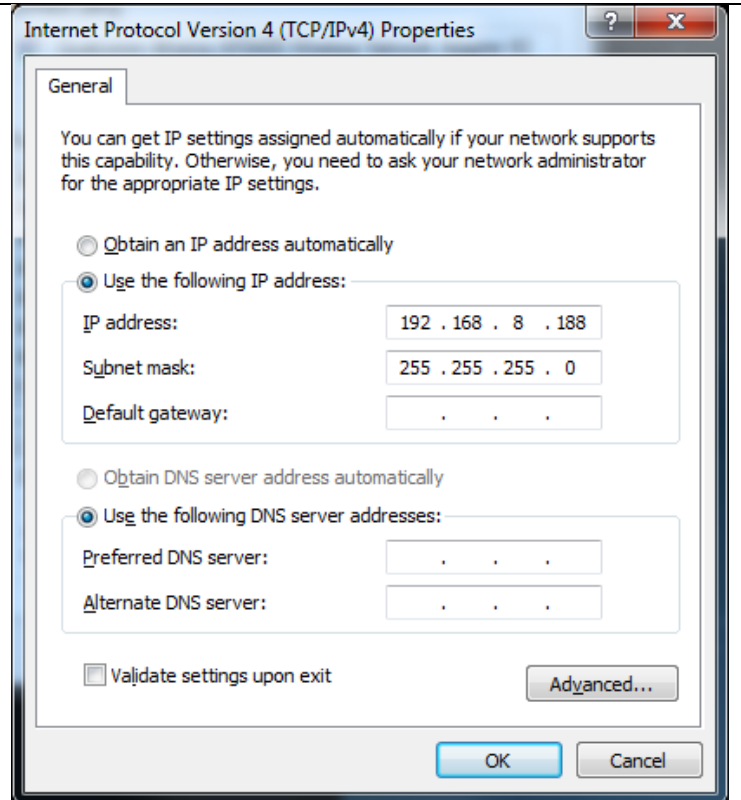

- Open local wireless signal list
- Select SSID which named as “FPD-detector SN”.
- Input Default Password “12345678” and connect the Panel AP.

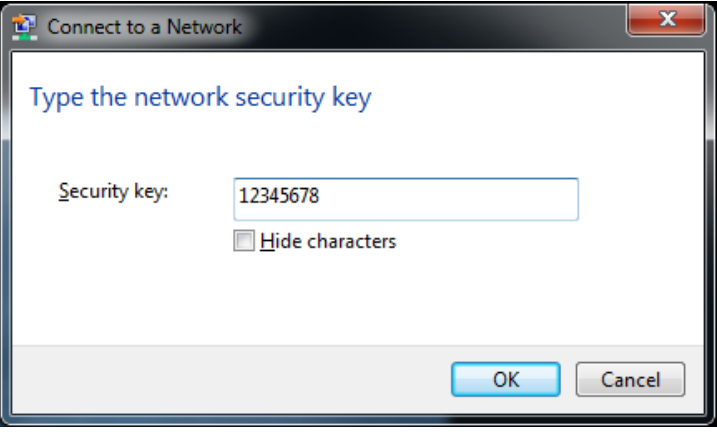
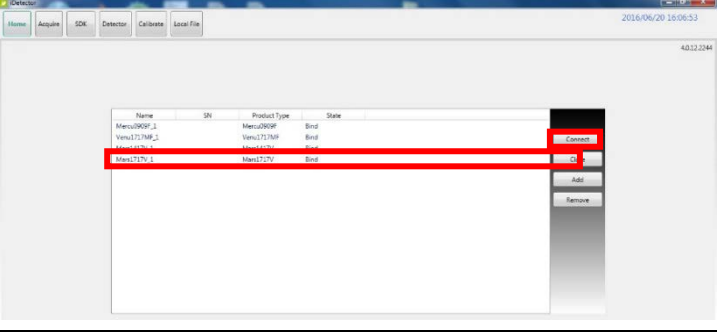

<ul style="list-style-type: none"> ● Select SSID which belongs to detectors; ● Input password and log into system 	
<ul style="list-style-type: none"> ● Open SDK and choose product start connection 	
<ul style="list-style-type: none"> ● After logging in the detector, User can Custom AP setting or Set the Wireless Client Mode 	

4.5.2 Configuration of detector

Wired cable can be used to configure panel wireless AP mode. The wired connection should be used by the service operator only. To start wired cable configuration, users should finish 4.4, then proceed to the steps below.

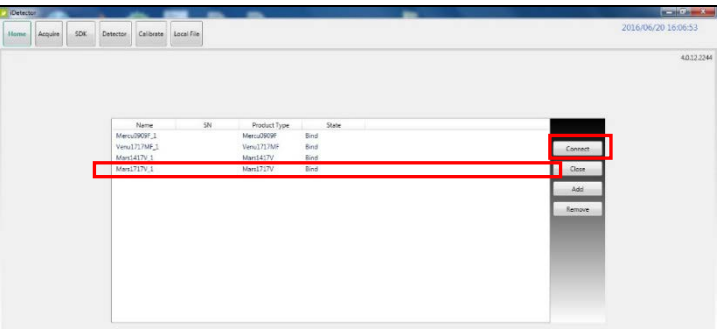
<ul style="list-style-type: none"> ● Connect panel to Workstation with Ethernet Cable like 4.4 	
---	--

- Click "Detector"

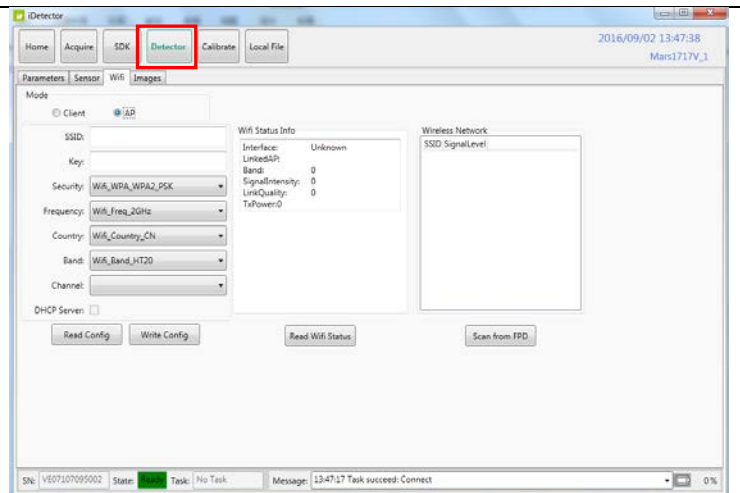

- Select "wifi"

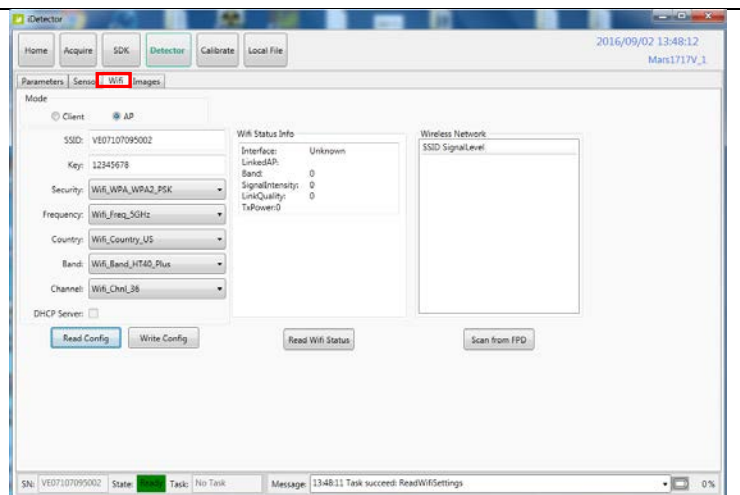

- Choose AP mode

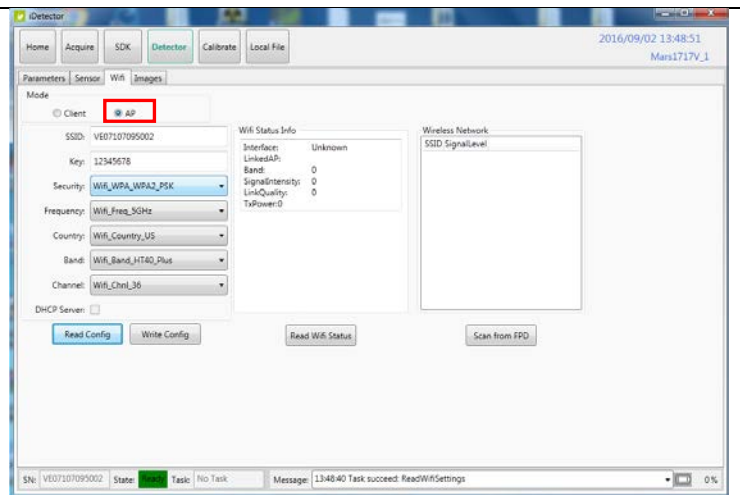

- Click "Read Config" to get default setting.
- Change SSID and password setting.
- make sure SSID is different from other already exist;

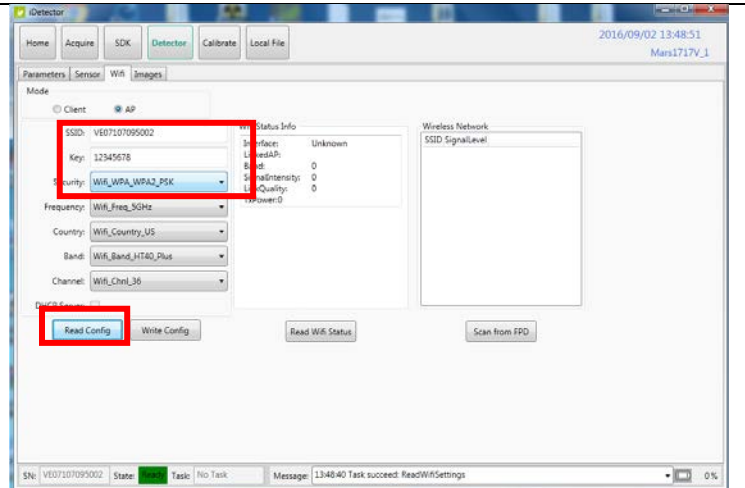

- Change channels and frequency setting

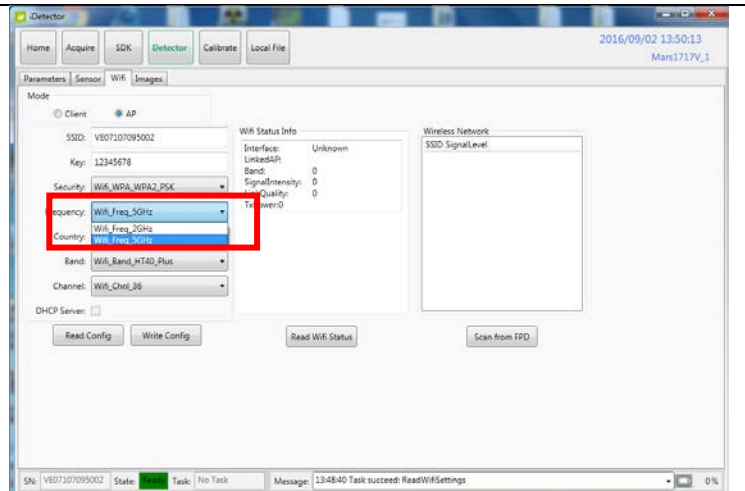

- Click "Channel" and choose a clean frequency and channel

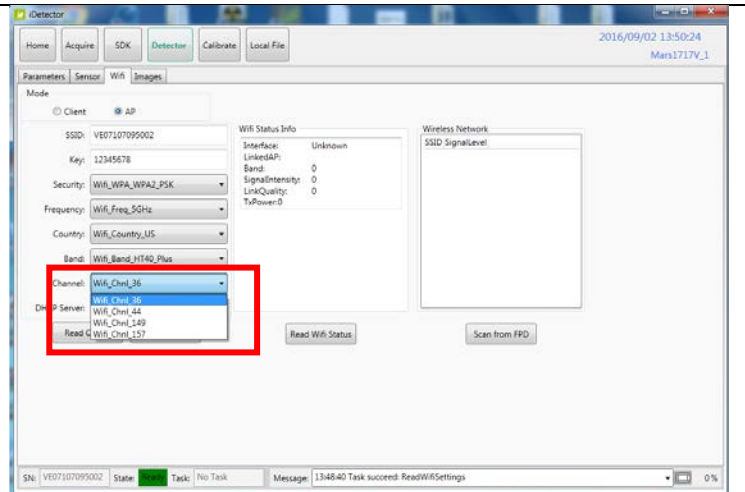

- Click "write config"

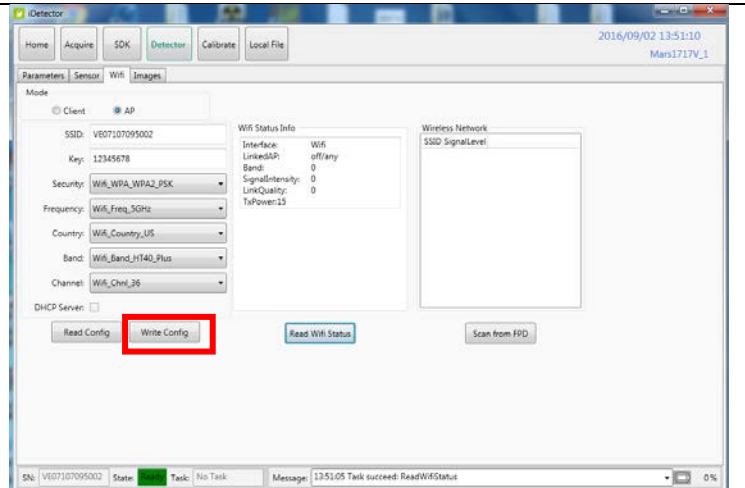

- Do not remove wired cable until FPD status from Busy become "Ready"

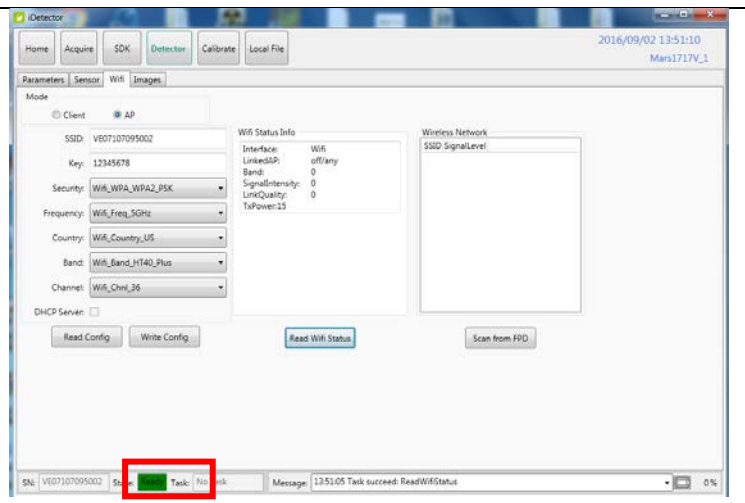

Configuration of external wireless card

- Open local wireless signal list



- Select SSID which belongs to detectors;
- Input password and log into system

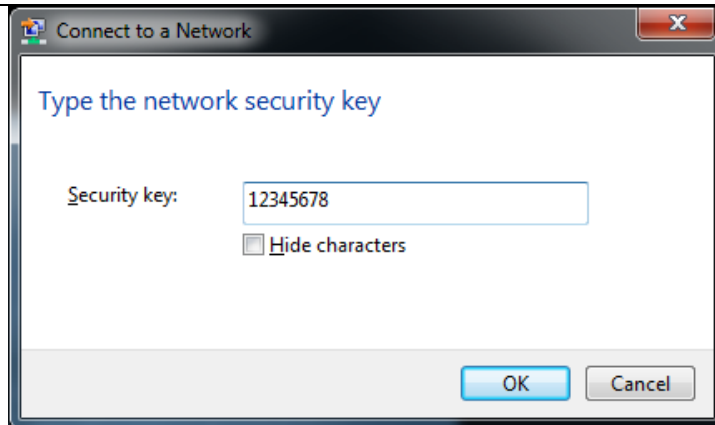

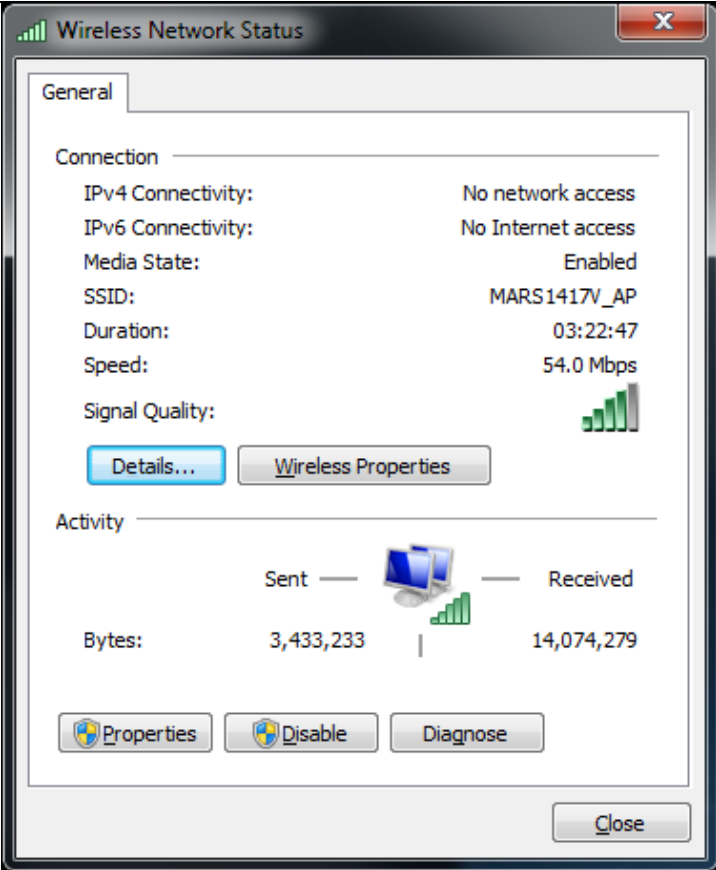
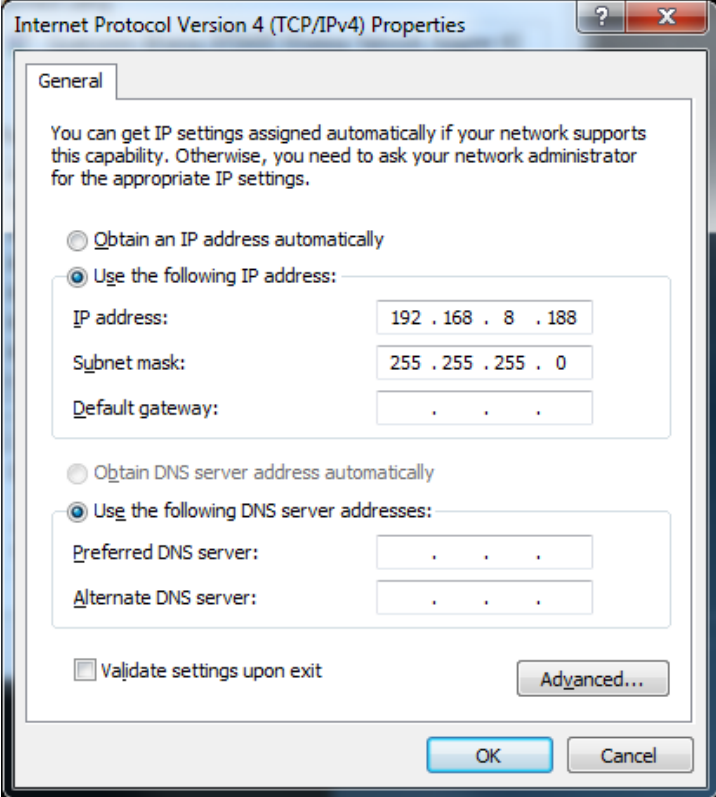
<ul style="list-style-type: none"> ● Open wireless card configuration 	
<ul style="list-style-type: none"> ● open IPV4 setting 	
<ul style="list-style-type: none"> ● IP setting as follows ● IP address: 192.168.8.188 	<p>IP address: 192.168.8.188</p> <p>Subnet mask: 255.255.255.0</p>

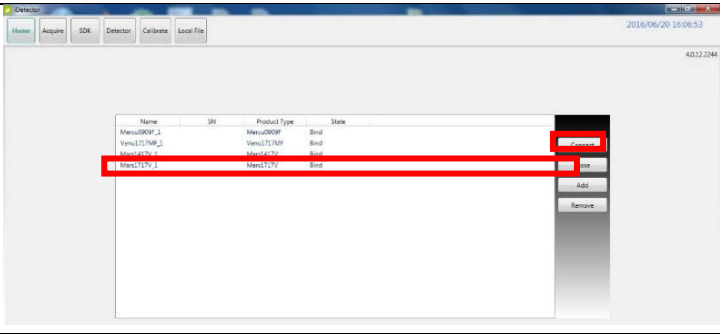
<ul style="list-style-type: none">● Subnet mask: 255.255.255.0																	
<ul style="list-style-type: none">● Open SDK and choose product start connection	 <p>The screenshot shows the Detector SDK interface. At the top, there are menu options: Home, Acquire, SDK, Detector, Calibrate, and Local File. The date and time are 2016/06/20 16:08:53, and the device ID is 4012.2244. Below the menu is a table with columns: Name, SN, Product Type, and State. The table contains three rows of data. A red box highlights the 'Connect' button in the right-hand column of the first row.</p> <table border="1"><thead><tr><th>Name</th><th>SN</th><th>Product Type</th><th>State</th></tr></thead><tbody><tr><td>Memo0001_1</td><td></td><td>Memo0001</td><td>Bind</td></tr><tr><td>Venu21TM_1</td><td></td><td>Venu21TM</td><td>Bind</td></tr><tr><td>Memo121_1</td><td></td><td>Memo121</td><td>Bind</td></tr></tbody></table>	Name	SN	Product Type	State	Memo0001_1		Memo0001	Bind	Venu21TM_1		Venu21TM	Bind	Memo121_1		Memo121	Bind
Name	SN	Product Type	State														
Memo0001_1		Memo0001	Bind														
Venu21TM_1		Venu21TM	Bind														
Memo121_1		Memo121	Bind														

4.6 Wireless Client Mode Connecton

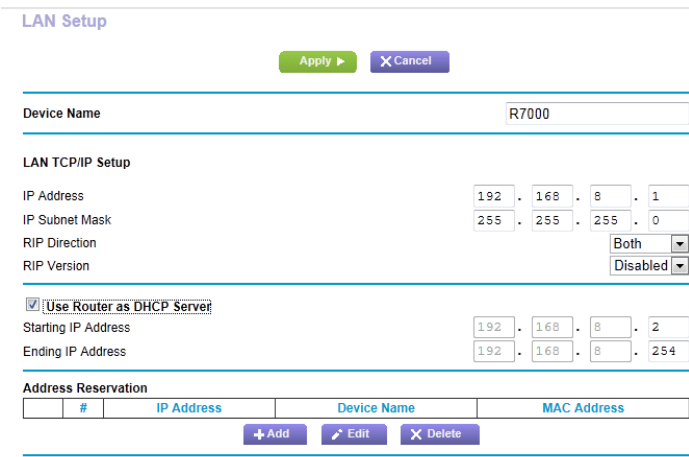
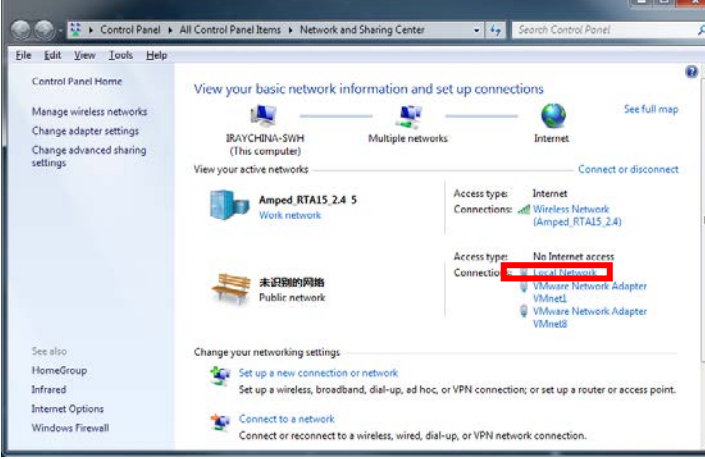
<p>1. Setup physical connection</p> <ul style="list-style-type: none"> ● Connect one end of Gigabit Ethernet Cable to Workstation, ● Connect another end to LAN port of External wireless AP refer to 4.4 and 4.5 	
<p>2. AP setup</p> <ul style="list-style-type: none"> ● Set up the Wireless AP to: ● IP address 192.168.8.1 ● Subnet Mask 255.255.255.0 ● The setting process will be virable depends on AP model ● Here shows the Netgear Wireless Router setup 	 <p>The screenshot shows the 'LAN Setup' configuration page for a Netgear router. At the top, there are 'Apply' and 'Cancel' buttons. The 'Device Name' is set to 'R7000'. Under 'LAN TCP/IP Setup', the IP Address is 192.168.8.1, the IP Subnet Mask is 255.255.255.0, the RIP Direction is 'Both', and the RIP Version is 'Disabled'. The checkbox 'Use Router as DHCP Server' is checked. Below this, the Starting IP Address is 192.168.8.2 and the Ending IP Address is 192.168.8.254. At the bottom, there is an 'Address Reservation' table with columns for '#', 'IP Address', 'Device Name', and 'MAC Address', and buttons for '+ Add', 'Edit', and 'Delete'.</p>
<ul style="list-style-type: none"> ● Open local network management interface 	 <p>The screenshot shows the Windows Network and Sharing Center. It displays network information for 'RAYCHINA-SWH (This computer)'. Under 'View your active networks', there are three entries: 'Amped RTA15.2.4 5 Work network' (Access type: Internet, Connections: Wireless Network), '未识别的网络 Public network' (Access type: No Internet access, Connections: Local Network), and 'VMware Network Adapter VMnet1' and 'VMware Network Adapter VMnet8'. The 'Local Network' connection is highlighted with a red box.</p>

- Right click the network adapter, select properties and entered the Local connection Properties window as shown left.
- Double click IPV4 item

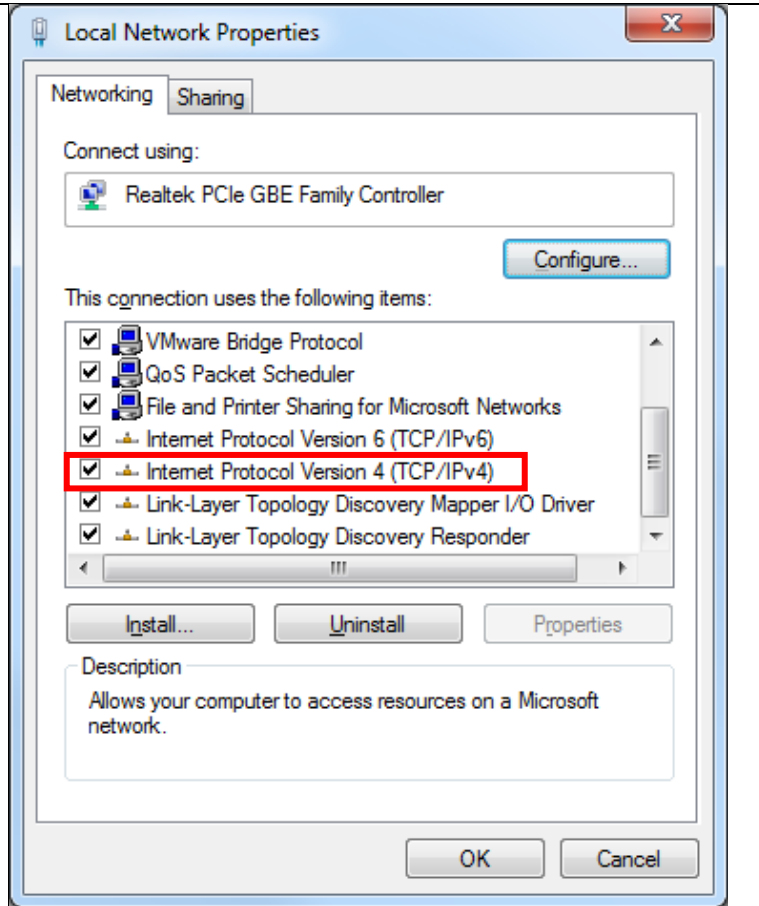

- Select "Obtain an IP address automatically"

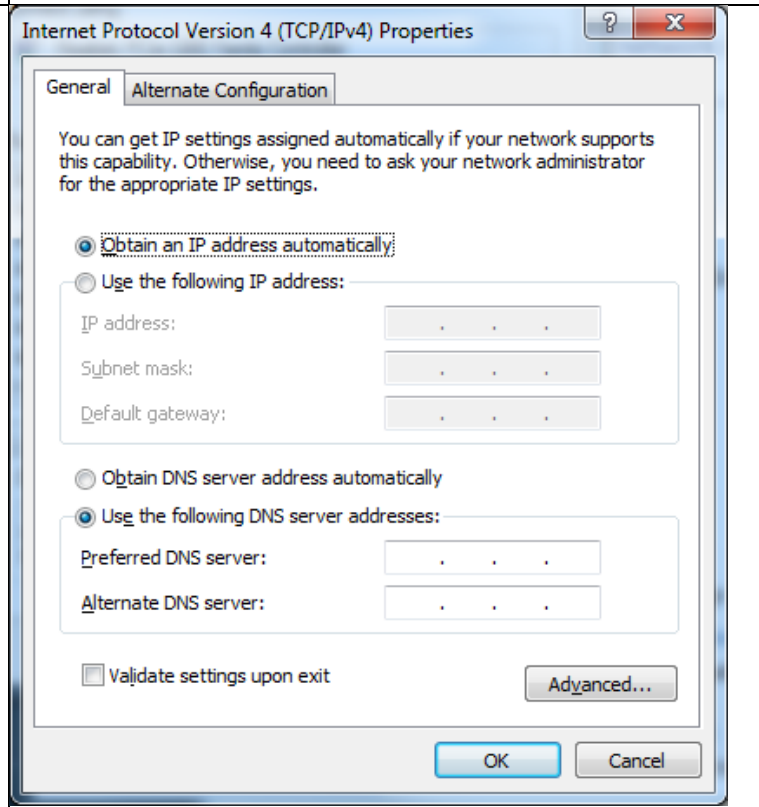

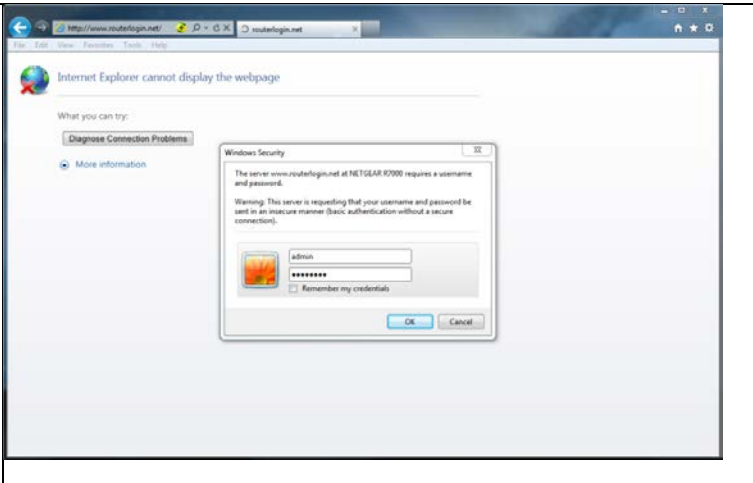
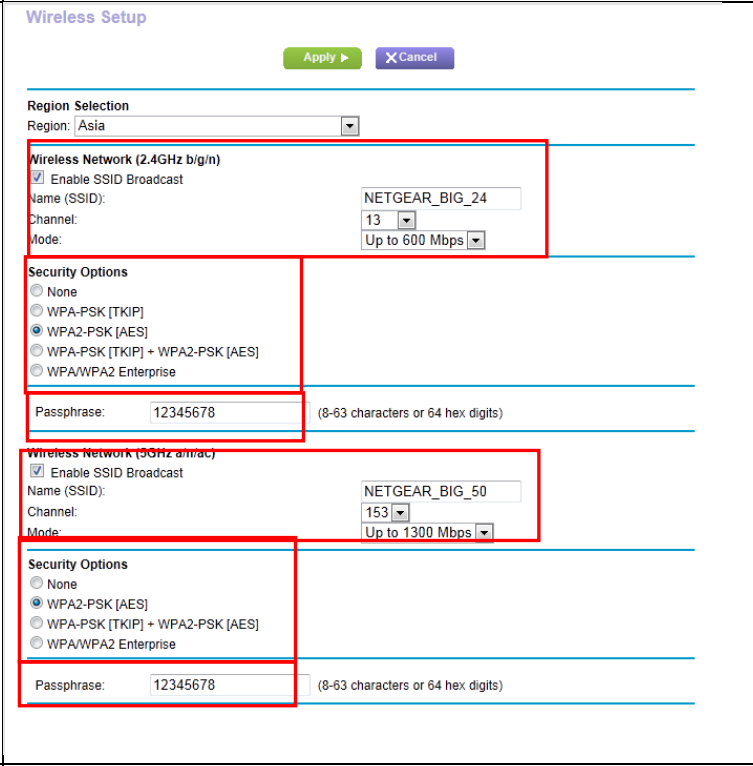
<ul style="list-style-type: none"> ● Open browser and type 192.168.1.1 ● Log into external wireless AP 	
<ul style="list-style-type: none"> ● Wireless setup 	
<ul style="list-style-type: none"> ● Configure 2.4GHz wireless network 	<ul style="list-style-type: none"> ● SSID: NETGEAR_BIG_24 ● Security: WPA2-PSK ● Password: 12345678 ● Channel: [Please check the current Wi-Fi environment, and choose a relatively clean channel]
<ul style="list-style-type: none"> ● Configure 5GHz wireless network 	<ul style="list-style-type: none"> ● SSID: NETGEAR_BIG_50 ● Security: WPA2-PSK ● Password: 12345678 ● Channel: [Please check the current Wi-Fi environment, and choose a relatively clean channel]

- LAN setup
- Configure LAN IP address
- IP address: 192.168.8.1
- Subnet Mask: 255.255.255.0
- The AP setup is done

LAN Setup

Apply ▶ Cancel

Device Name: R7000

LAN TCP/IP Setup

IP Address: 192 . 168 . 8 . 1

IP Subnet Mask: 255 . 255 . 255 . 0

RIP Direction: Both

RIP Version: Disabled

Use Router as DHCP Server

Starting IP Address: 192 . 168 . 8 . 2

Ending IP Address: 192 . 168 . 8 . 254

Address Reservation

#	IP Address	Device Name	MAC Address

+ Add Edit Delete

3. Workstation IP setup

- After AP setup done, the user can setup the Workstation IP address
- Open local network management interface

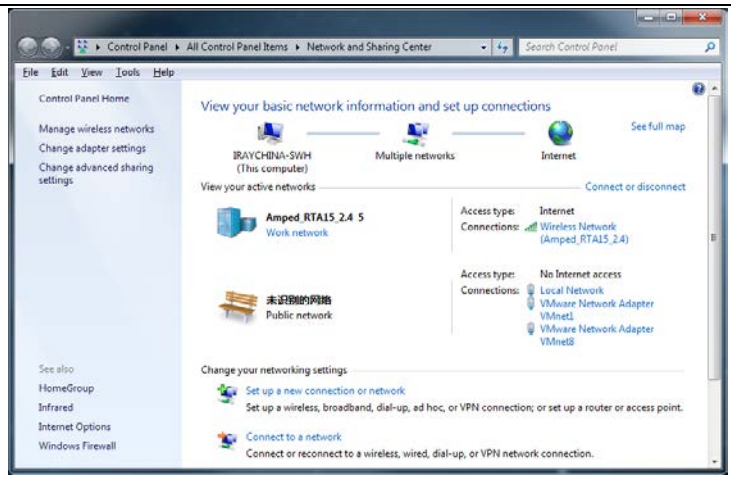

- Right click the network adapter, select properties and entered the Local connection Properties window as shown left.
- Double click IPV4 item

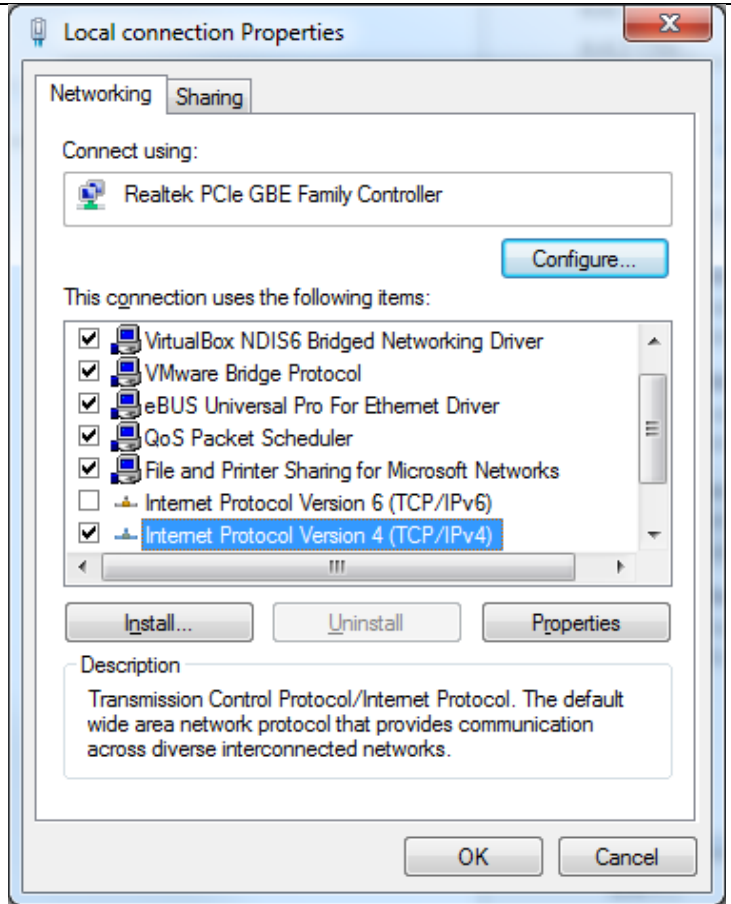

- Set the Default IP as follows:
- IP address : 192.168.8.188
- Subnet mask : 255.255.255.0

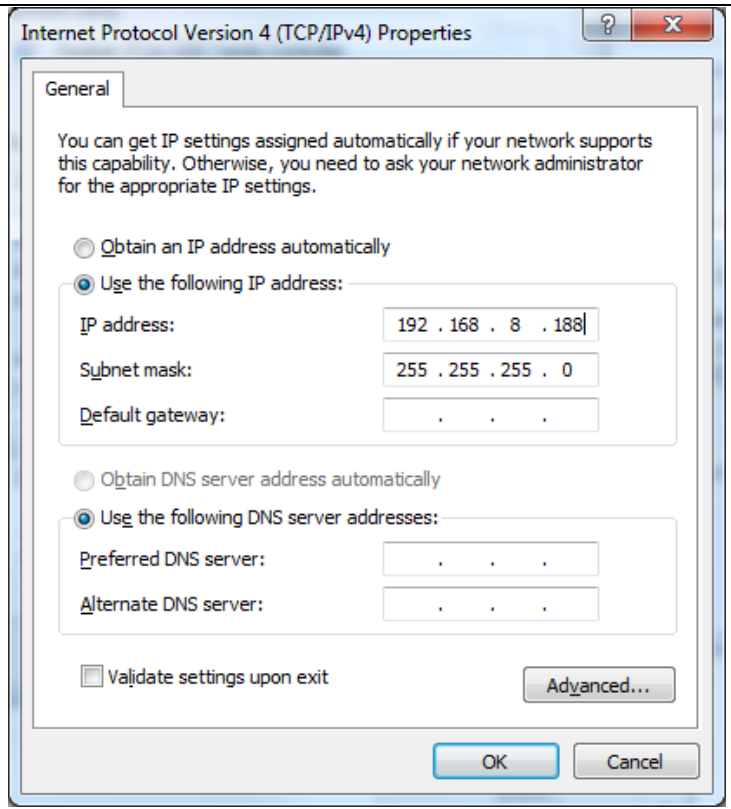

- The IP address should be identical with Cfg_HostIP item in work_dir\Mars1717V3\config.ini file.

```

[System]
Cfg_DetectorImp=E4W
Cfg_ConnImp=ConnUdpTcp
Cfg_CaliImp=CaliE4W
Cfg_LogLevel=1
Cfg_UseServiceProcess=1
Cfg_ProtocolEdition=4
Cfg_ProductNo=61
Cfg_SN=

[Connection]
Cfg_HostIP=192.168.8.188
Cfg_HostPort=28000
Cfg_ComPort=1
Cfg_PleoraConnStr=
  
```

4. Panel setup

- Either Wired Cable or AP mode can be used to configure detector
- To start configuration with wired cable. It is necessary to finish 4.4, then proceed to the steps below.
- To start configuration with AP. It is necessary to finish 4.5, then proceed to the steps below.



- Connect panel to Workstation like 4.4 or 4.5

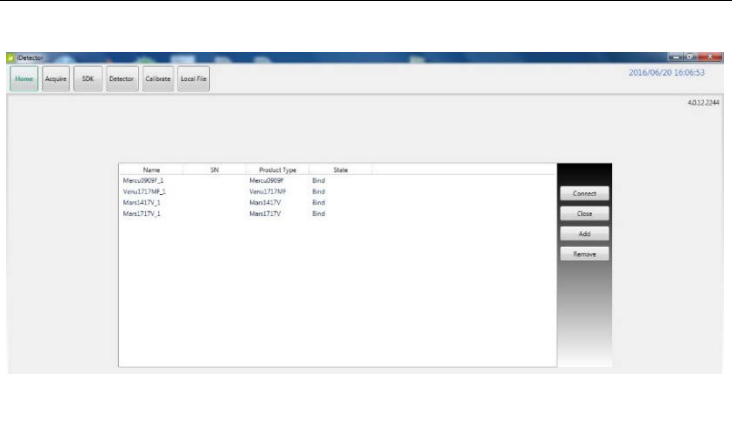

- Click “Detector”
- Click “Read Config”
- Choose Client mode

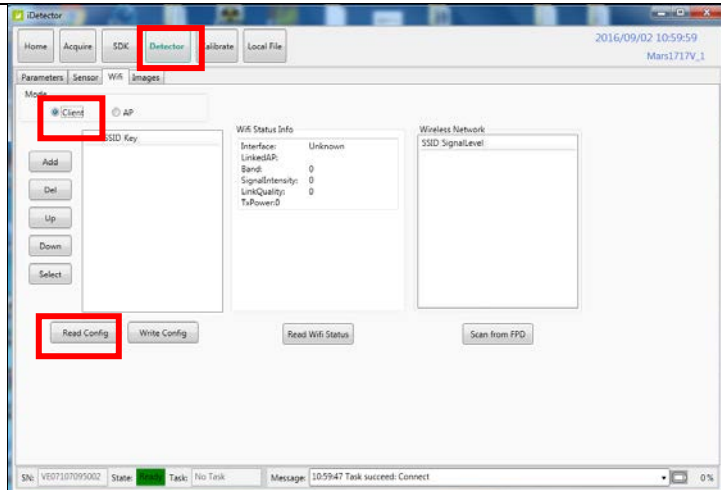

- Click “Add”
- Type SSID and Password
- Click “Apply”

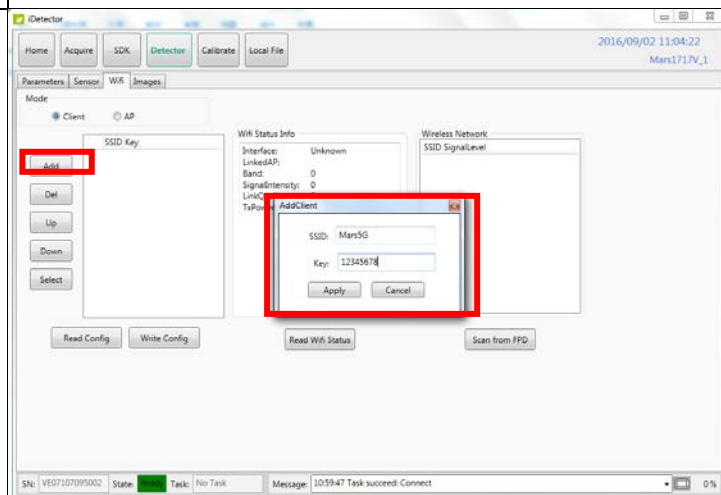

- Choose SSID and select (There will be ✓ occurred)
- Click “write config” to save parameters.

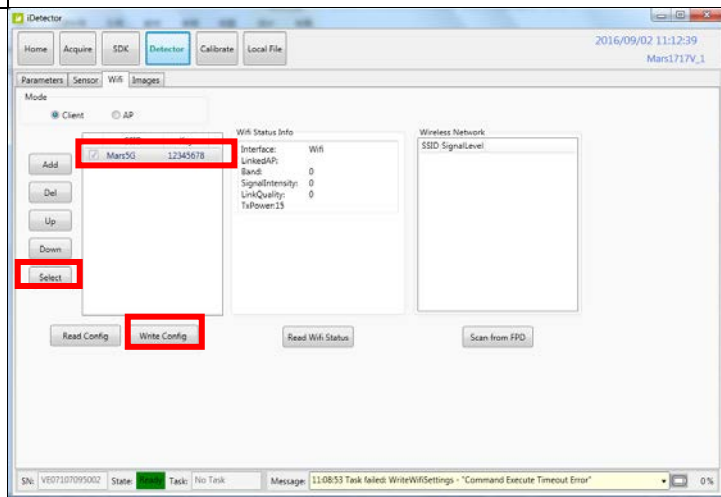

- Turn on wireless router.
- Make sure there are wired connection between router and work station and IP 192.168.8.188.
- Click “Read wifi Status” to check wireless transmission status, numerical value occurred means the link is up and available.

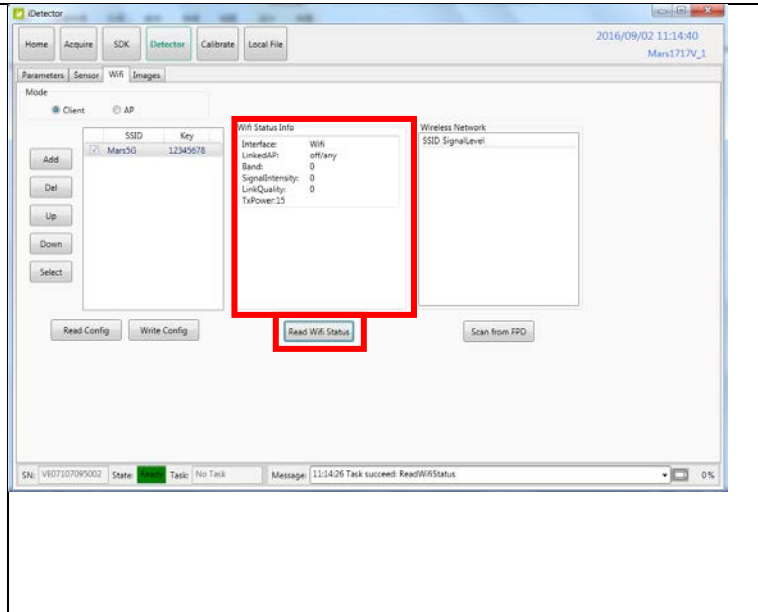

Since we have chosen default SSID and password, it would connect to wireless AP immediately after powered on next time.

4.7 iDetector software

SDK supply iDetector as tool software:

32-bits iDetector.exe: Tools\iDetector\w32

64-bits iDetector.exe: Tools\iDetector\x64

Double click iDetector.exe to run the software. For different software version, the UI maybe have little difference. If change, forgive us for not issuing a separate notice.

Users can refer to 903-341-14_iDetector_UserManual_EN_A4 for specific operation methods.

Tab	Function description
Home	Connect FPD and view the connect state
Acquire	Acquire image, select correction mode, save image and process image
SDK	config.ini setting, log level setting
Detector	Configurate parameters for detector.
Calibrate	Generate calibration files and manage the calibration files
Local File	Open and view local images.

4.7.1 HomePage

The main function in this page is to connect detector.

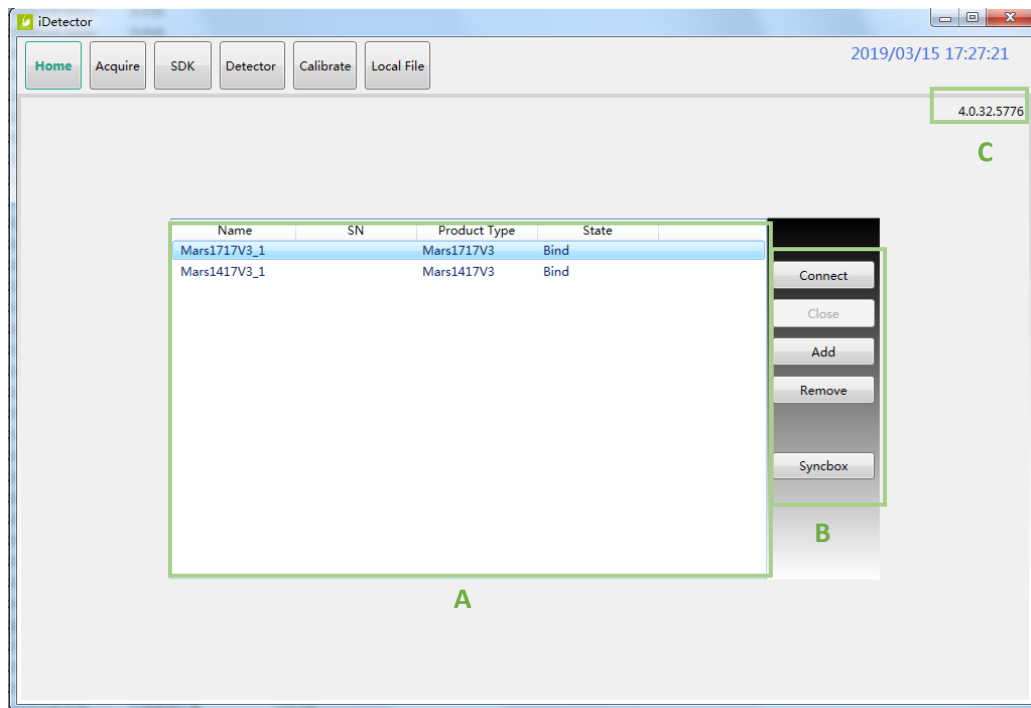

A

Item	Function description
Name	Display the name of detector
SN	Display the SN of detector
Product Type	Display the type of detector
State	Display the connection state (Bind, Unknown, Ready etc.)

B

Button	Function description
Connect	Click this button to connect the selected detector.
Close	Click this button to disconnect the selected detector.
Add	Add work directory
Remove	Remove work directory
Syncbox	Open Syncbox configuration window(Optional device)

C

The version of the SDK is displayed here, and the information will vary depending on the SDK version.

4.7.2 Acquire Page

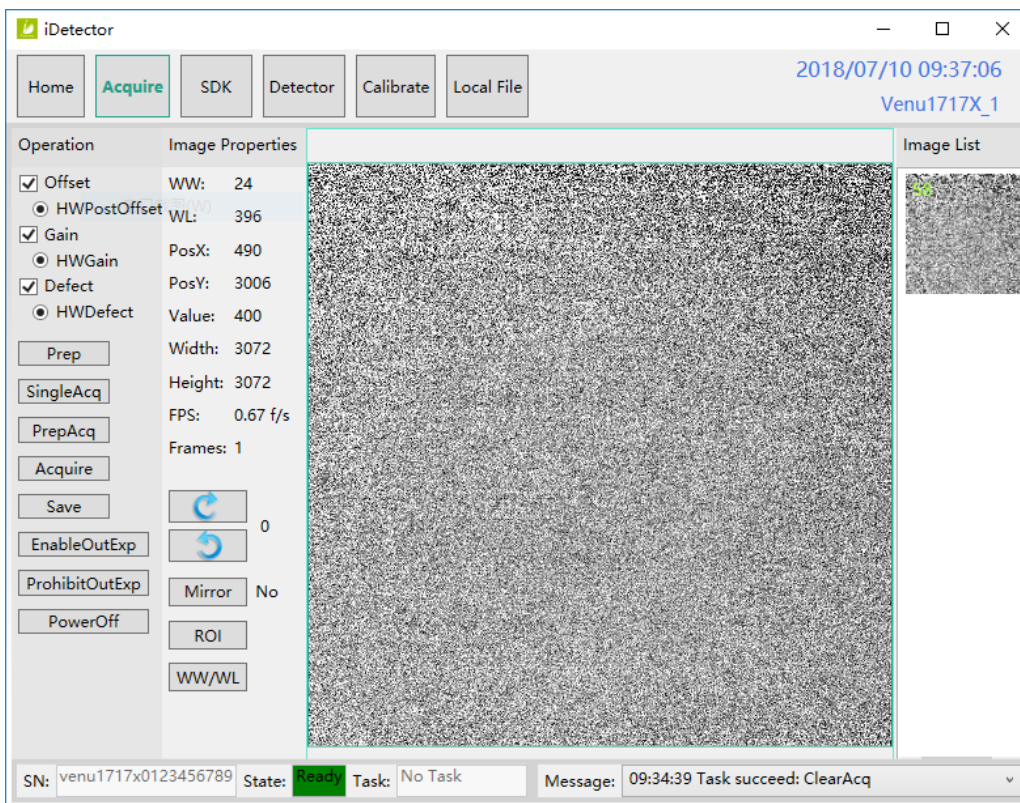

This page is used to acquire image under different work mode, and user can choose correction mode too. When acquire image finished there will be a preview image shown on the screen. The properties of image is displayed on the left of preview image. On the right of preview image there is a list to show thumbnail of images. User can select it and double click to see for detail. User can rotate, reverse or mirror image. User can get the value of AVG and SNR by ROI tool. The acquired images can be save as raw, tiff or dicom formats. Both raw and tiff formats support single frame and continuous frames save.



Status bar shows detector's serial number, the current task and state of detector, and feedback information of command. Status bar is also can be seen in other pages, and they are all same.

Item	Description
SN	SN number of current connected detectors
State	Detectors state , e.g busy, ready
Task	the current task of detector
Message	feedback information of command,e.g. succeed,failed

Functions in this Page.

Correction Menu		Description
Offset	HW-PostOffset	Do hardware PostOffset correction for image if checked(Only for Mars detector)
Gain	HWGain	Do hardware Gain correction for image if selected
Defect	HWDefect	Do hardware defect correction for image if checked(for Mars and Mercu detector)
Acqurie Button		Description
Prep		Clear. Prepare to integrate.
SingleAcq		Acquire once
PrepAcq		Clear and acquire
Acquire		Seriers acquire images
Save		Save image, the format is raw and tiff
EnableOutExp		Allow outer trigger
ProhibitOutExp		Disable outer trigger
Poweroff		shutdown detector
Image Properties& Image Process		Description
WW		window width
WL		window level
PosX		X coordinates of the current cursor at the point
PosY		Y coordinates of the current cursor at the point
Value		Value of the current cursor at the point
Width		Image width
Height		Image height
FPS		Frame rate
Frames		Display the frame count
		Rotate the image clockwise, 90 degrees every time.
		Rotate the image anticlockwise, 90 degrees every time.
Mirror		Open or close mirror
ROI		ROI tool, to view the image of the AVG, SV, SNR and other parameters. Press "ctrl" key, can create several ROI area.

WW/WL	Auto adjust WW/WL based on selected area by right button of mouse.
Image List	Show thumbnails

4.7.3 *Detector Page*

In Detector page, Detector Parameters, Sensor, Wifi and Images tab could be set.

Please refer to 903-341-14_iDetector_UserManual_EN_A4, for specific operation guide.

4.7.4 *Calibrate Page*

Offset, Gain, Defect calibrate files can be generated and managed in this page.

Please refer to 903-341-14_iDetector_UserManual_EN_A4, for specific operation guide. Users can also refers to chapter 5.2 for panel Correlation and Calibration tutorial.

4.7.5 *Local Page*

The idetector Software includes a local images display tool that allows users to look up local images.

Please refer to 903-341-14_iDetector_UserManual_EN_A4 for specific operation methods.

4.8 List of the HAZARDOUS SITUATIONS resulting from a failure of the IT-NETWORK

- a) The operating system is not compatibility;
- b) Change or upgrade the software failed;
- c) The compatibility of the interface;
- d) The data transfer protocol error;
- e) The inconsistent of interface or format leads to data distortion;
- f) The data output failed;

5. Operation

5. OPERATION	70
5.1 Main Operation	71
5.1.1 Steps for acquiring image	72
5.1.2 Software Mode.....	73
5.1.3 Inner Mode.....	76
5.1.4 FreeSync Mode	79
5.1.5 After Use.....	80
5.2 Correction and Calibration Template Generation.....	81
5.2.1 HW pre-offset Template Generation.....	81
5.2.2 Gain Calibration Template Generation.....	82
5.2.3 Defect Correction Template Generation.....	83
5.3 Local Image Check.....	85
5.4 Firmware Upgrade.....	87
5.5 Shock sensor.....	89

Mars1717V provides SDK for user to integrate panel into their DR system.

Additionally, it also provides an application for demonstration, i.e. iDetector. User can use iDetector to control panel without DR system.

5.1 Main Operation

To Acquire X-ray image is the main operation of Mars1717V. Most importantly, panel should build synchronization with X-ray generator. Mars1717V is born with four ways to acquire X-ray image that is Software Mode, Inner Mode, Prep Mode and FreeSync Mode.

5.1.1 Steps for acquiring image

- Make sure the hardware is connected correctly and then power on.
- Once powered off, please wait at least 60s before power on again
- Wait until initialization is complete
- Connect the software
- choose the synchronization mode
- Generate HWPreOffset, Gain and Defect template after the detector reaches thermal equilibrium
- Acquire images in the selected mode

To Acquire X-ray image is the main operation of Mars1717V. Most importantly, detector should build synchronization with X-ray generator. Mars1717V has four synchronization modes to acquire X-ray image, which is Software Mode, Prep Mode, FreeSync Mode and Inner Mode.

5.1.2 Software Mode

5.1.2.1 Block Diagram

Software mode is the basic way to acquire x-ray image. Please see figure below for general feature

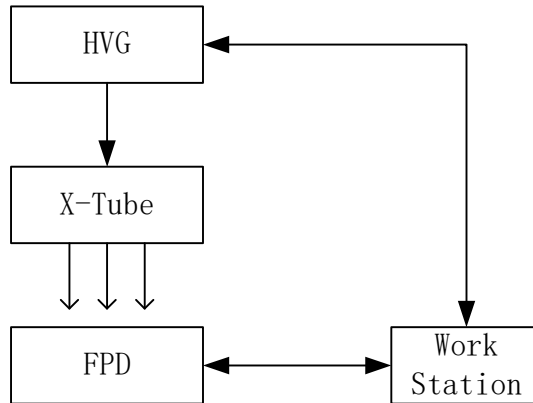

Workstation is a host device installed with iDetector and SDK. Chapter 3 has described how to establish connection between panels and workstation. In software mode, workstation does not control x-ray generator. Users would decide when to shoot x-ray.

5.1.2.2 Work flow

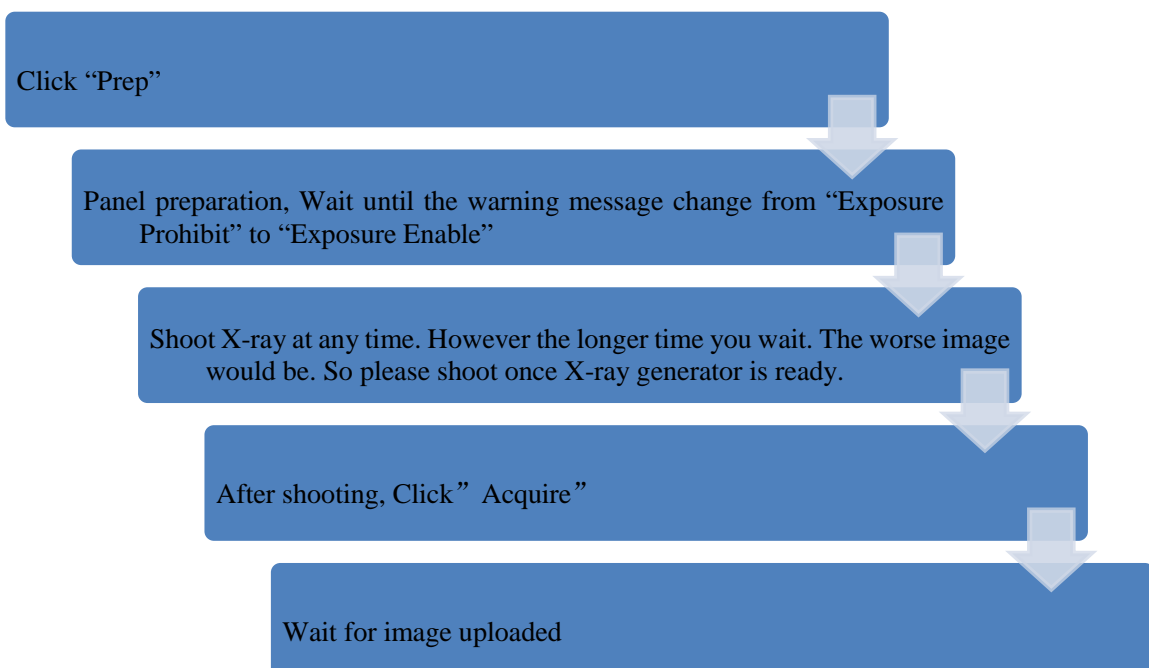

5.1.2.3 Timing Setting

To set a clear scenario for programming, see diagram below for details

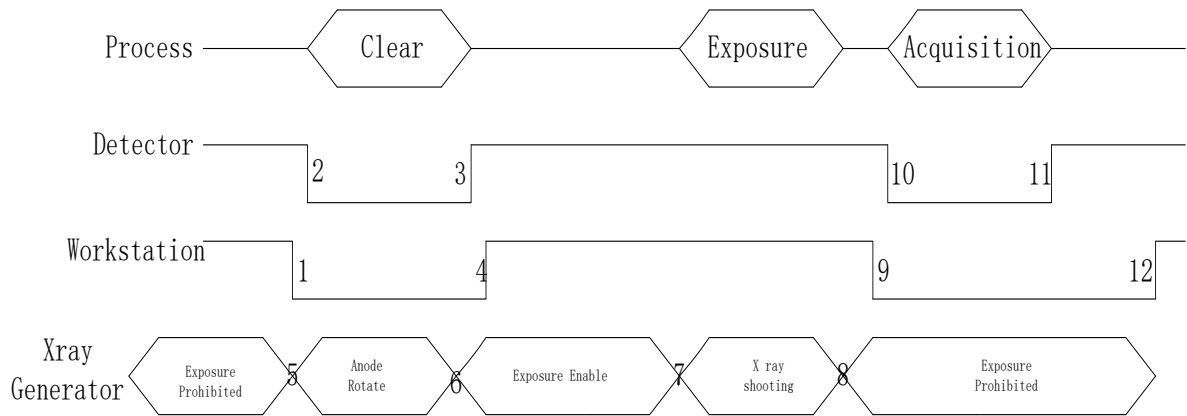

1. Workstation receives “prep” request, send command “Clear” to panel.
2. Panel receives “clear” from workstation, starts clearing leakage of panel. Meanwhile, panel send a message to workstation “Exposure Prohibited”.
3. Panel finishes “Clear” and send a message to workstation “Exposure Enable”.
4. Workstation shows “Exposure Enable” on the IDetector’s message bar to tell user shoot X-ray now.
5. User triggers X-ray generator to initialize and do anode rotation to prepare for X-ray shooting.
6. X-ray generator finishes preparation for X-ray shooting and reminds user to shoot.
7. X-ray generator starts releasing X-ray.
8. X-ray generator finishes x-ray shooting.

-
9. Workstation receives “Acquire” request, send command “Data Acquisition” to panel.
 10. Panel receives “Data Acquisition” from workstation, start data acquisition operation.
 11. Panel completes image acquisition and begins to send data to workstation.
 12. Workstation receives all image data from panel

If Hardware Pre-offset and Hardware calibration is selected, image is the final image.

If Hardware Post offset and Hardware calibration is selected, image got would be preview image. After step12, panel would do another dark image acquisition. With both light image and dark image, panel completes all the correction and calibration process. Finally, panel uploads processed image to workstation.

5.1.3 Inner Mode

5.1.3.1 Block Diagram

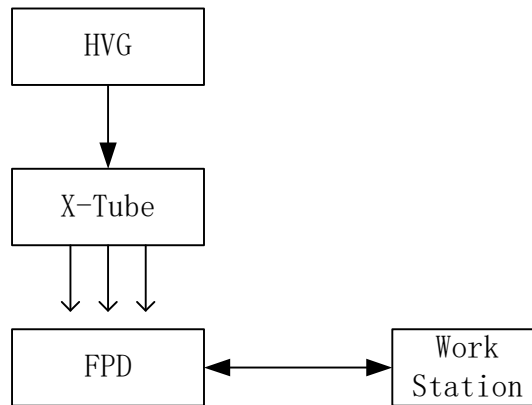

Workstation is a host PC device installed with IDetector and SDK. Chapter 3 has described how to establish connection between panels and workstation. In inner mode, workstation does not control X-ray generator. Users would decide when to shoot X-ray.

5.1.3.2 Work Flow

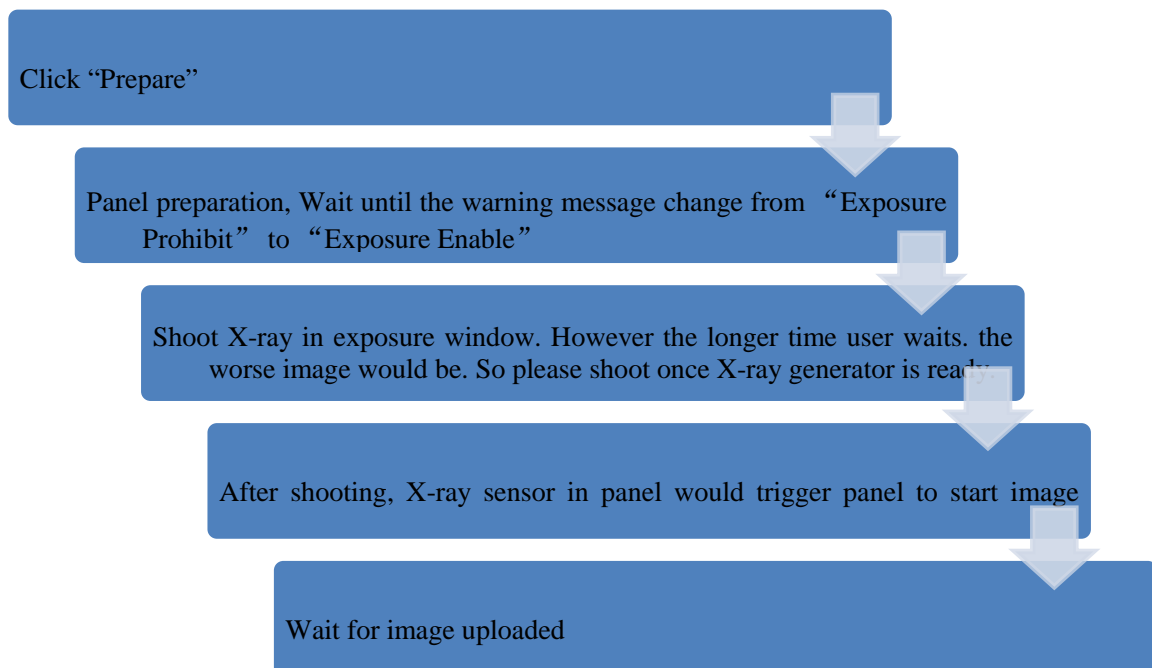

5.1.3.3 Timing Setting

To set a clear scenario for program, see diagram below for details

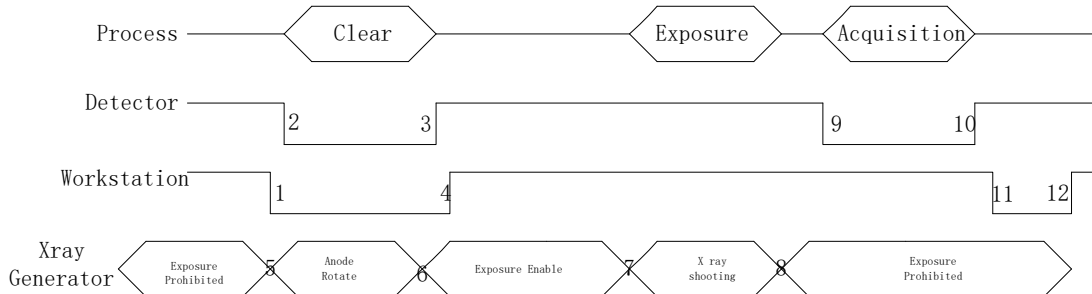

1. Workstation receives “prep” request and sends “Clear” to panels.
2. Panel receives “clear” from Workstation, start clear operation. Meanwhile, panel would send “Exposure Prohibited” to Workstation.
3. Panel finishes”Clear” operation and send “Exposure Enable” to Workstation.
4. Workstation shows “Exposure Enable” on the iDetector’s message bar to tell user shoot X-ray.
5. User triggers X-ray generator to initialize and do anode rotation to prepare for X-ray shooting
6. X-ray generator finishes preparation and reminds users.
7. X-ray generator begins releasing X-ray
8. X-ray generator finishes X-ray shooting.
9. X-ray sensor in panel triggers panel to start image acquisition operation.
10. Panel completes image acquisition and begins to send data to Workstation.
11. Workstation starts receiving image data from panel.

12. Workstation receives all image data from panel which are after calibration is Hardware calibration is on.

If Hardware Pre-offset and Hardware calibration is selected, image got is the final image.

If Hardware Post offset and Hardware calibration is selected, image got from detector would be preview image. After step12, Detector would do another dark image acquisition. With both light image and dark image, detector completes all the correction process. Finally, detector uploads corrected image and workstation shows on screen.

5.1.4 FreeSync Mode

5.1.4.1 Block Diagram

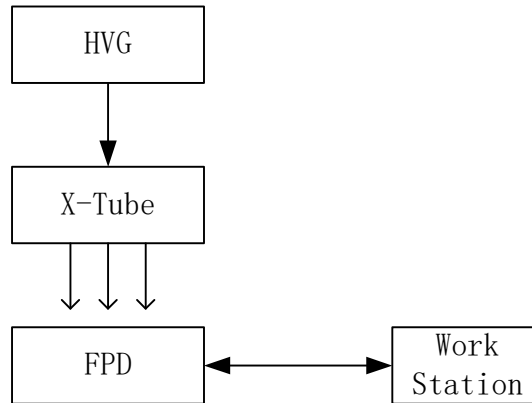

Workstation is a host PC device installed with iDetector and SDK. Chapter 3 has described how to establish connection between panel and Workstation. In FreeSync mode, User doesn't interact with Workstation. After shooting, images would be shown on screen immediately.

5.1.4.2 Work Flow

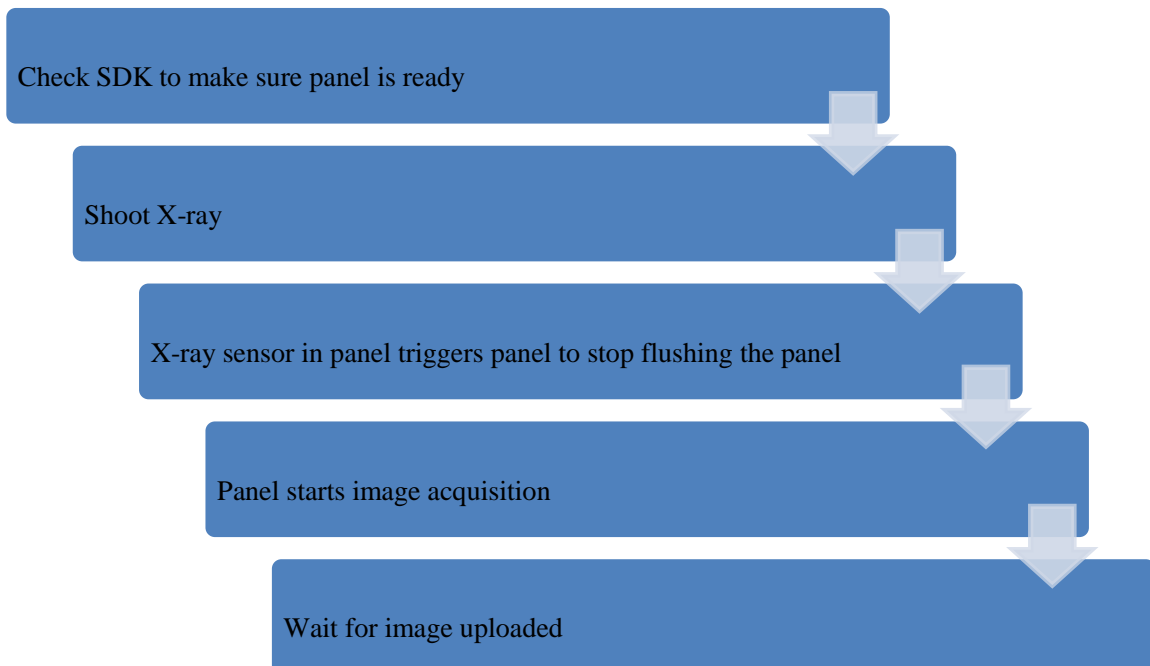

5.1.4.3 Timing Setting

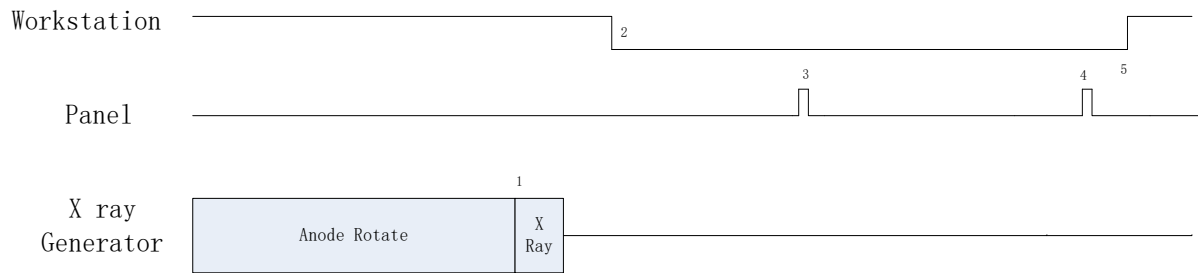

1. X-ray generator is ready for X-ray shooting and begins to release X-ray.
2. Workstation receives “Exposure Prohibited” from Panel.
3. If hardware offset is selected, panel would do offset first, and then upload preview image.
4. If hardware offset is chosen, panel would do correction and calibration first, then upload processed image to Workstation.
5. Workstation receives “Exposure Enable” from Panel.

5.1.5 After Use

1. Disconnect the software
2. Power off
3. Keep it clean
4. Store under specified conditions

5.2 Correction and Calibration Template Generation

The correction and calibration should be performed after installation and it is recommended to perform the new correction and calibration after any major change on the system settings and hardware configuration. On the other hand, it is also recommended to do the correction and calibration in each 6 months.

5.2.1 HW pre-offset Template Generation

<ul style="list-style-type: none">● Enter Acquire interface, select HWPostOffset option													
<ul style="list-style-type: none">● Enter Calibrate interface, click UpdateHWPreOffset button. Waiting until status bar displayed: "Task succeed: HwGeneratePreOffsetTemplate"	<thead><tr><th>Subset</th><th>Activity</th><th>Offset</th><th>Gain</th><th>Defect</th><th>Lag</th></tr></thead> <tbody><tr><td>Default</td><td>enable</td><td>absent</td><td>absent</td><td>absent</td><td>absent</td></tr></tbody>	Subset	Activity	Offset	Gain	Defect	Lag	Default	enable	absent	absent	absent	absent
Subset	Activity	Offset	Gain	Defect	Lag								
Default	enable	absent	absent	absent	absent								

 To the right of this table are buttons for 'Import to Workdir', 'Download to FPD', and 'Read Status'. The bottom section is 'Fpd template file' with a table:

Type	Index	Activity	Description
------	-------	----------	-------------

 To the right of this table are buttons for 'Upload to Workdir', 'Upload Lag', 'Read Status', 'Active', and 'UpdateHWPreOffset'. At the bottom right, a status bar displays the message: '10:12:06 Task succeed: HwGeneratePreOffsetTemplate'." data-bbox="404 435 862 645"/>

5.2.2 Gain Calibration Template Generation

If the relative position between tube and detector changed or KV value changed, it suggest to create gain template file.

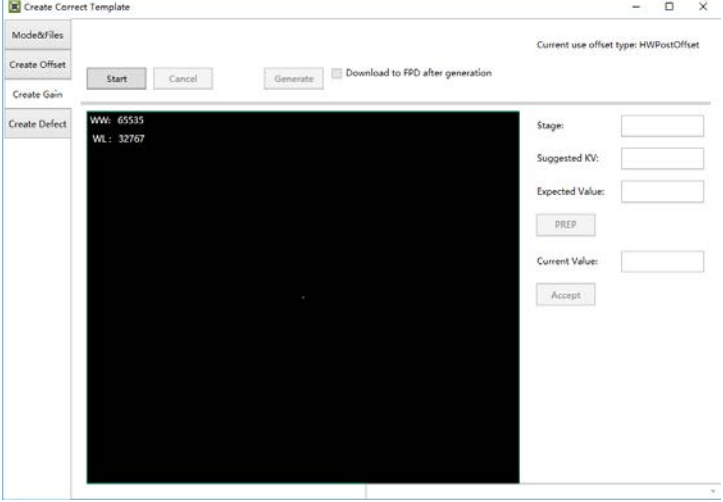
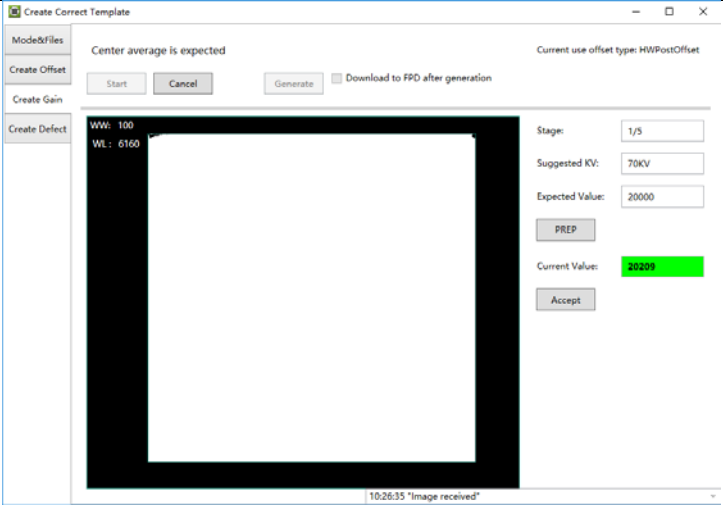
<ul style="list-style-type: none"> ● Enter Create Gain page 	
<ul style="list-style-type: none"> ● Click "Start" button to start process. 	
<ul style="list-style-type: none"> ● Click PREP button, acquire image. Please exposure after Acquire button enable. And click Acquire button to acquire image after exposure end. Click Accept button after acquired image. If Current Value textbox is yellow, click PREP button. Re-acquire images after adjust generator parameters. ● Note: In different trigger mode, the operation maybe have little difference. Please follow the UI tips. 	

- Create gain template need several images. You can click Generate button to generate Gain template once one image was captured. But it may lead to imperfect template quality.

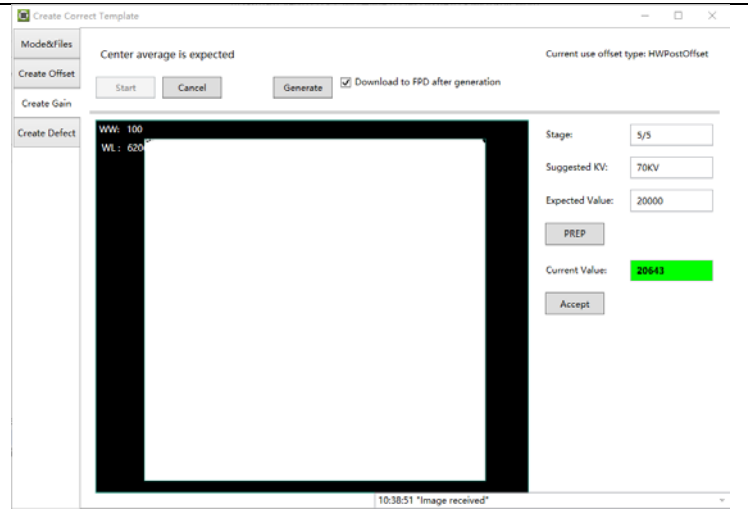

- Download template file dialog will pop up if "Download to FPD after generation" option was checked. Click Download button to download the template into the detector.

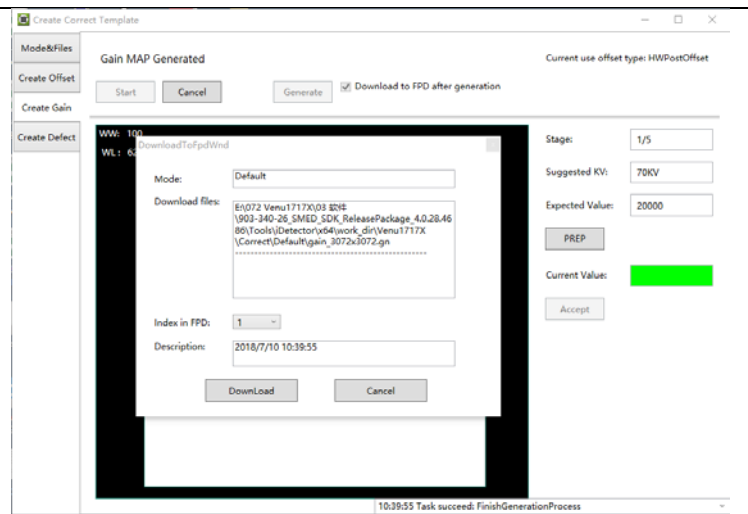

- Select Mode&Files tab. Click Read Status button to check whether just downloaded gain template is enable. If not, please click Active button to enable.

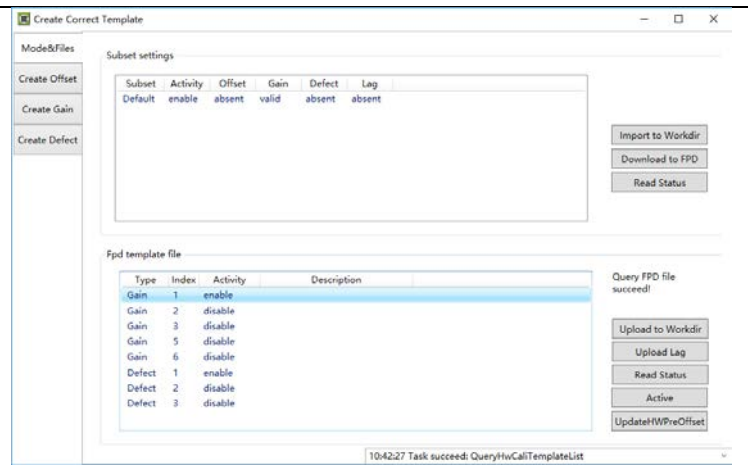

5.2.3 Defect Correction Template Generation

- Enter Acquire UI. Choose HWPostOffset.

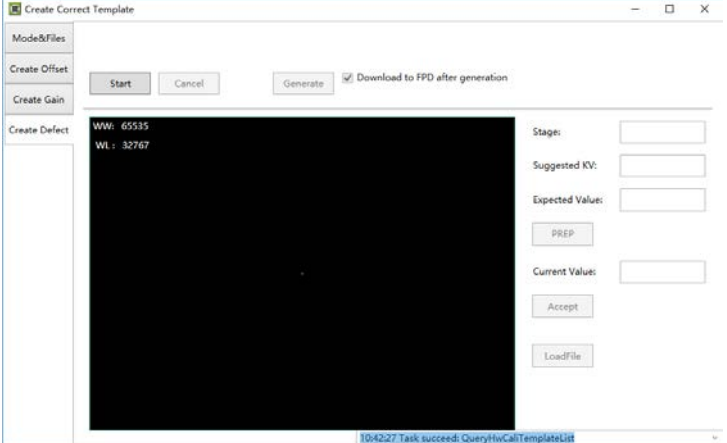
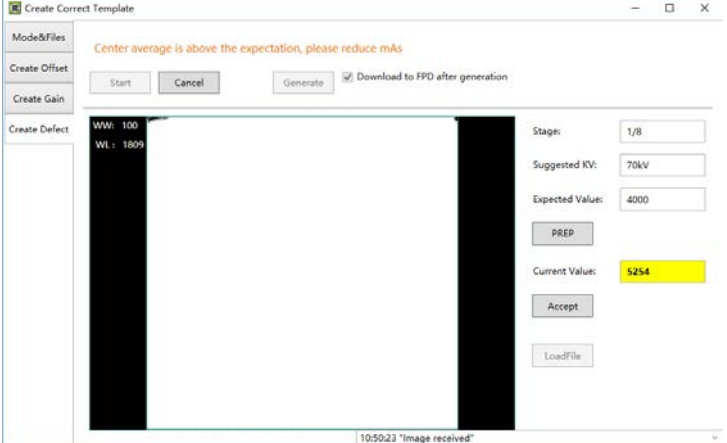
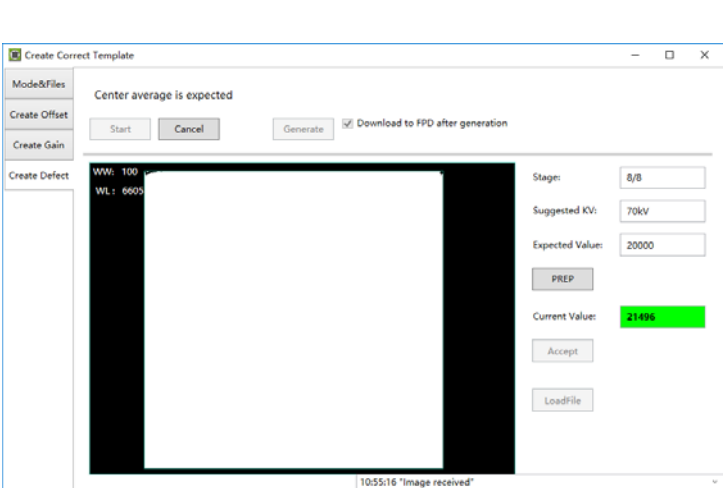
<ul style="list-style-type: none"> ● Enter Calibrate UI. Select Create Defect tab. 	
<ul style="list-style-type: none"> ● Click "Start" button to start process. ● Click PREP button, acquire image. Please exposure after Acquire button enable. And click Acquire button to acquire image after exposure end. Click 	
<ul style="list-style-type: none"> ● Accept button after acquired image. If Current Value textbox is yellow, click PREP button. Re-acquire images after adjust generator parameters. ● Note: In different trigger mode, the operation maybe have little difference. Please follow the UI tips. 	
<ul style="list-style-type: none"> ● You can click Generate button to generate Gain template after acquired required images. 	

- Download template file dialog will pop up if "Download to FPD after generation" option was checked. Click Download button to download the template into the detector.

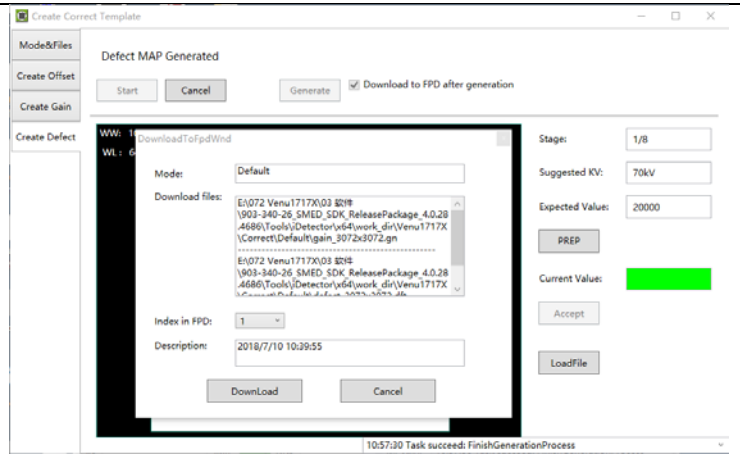

- Select Mode&Files tab. Click Read Status button to check whether just downloaded gain template is enable. If not, please click Active button to enable.

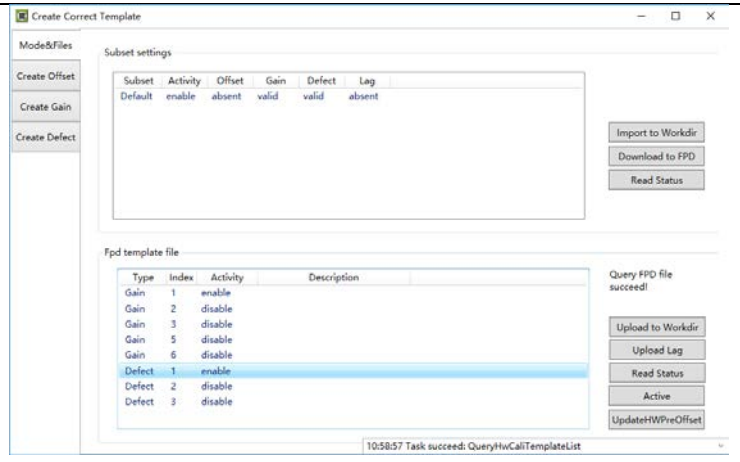

5.3 Local Image Check

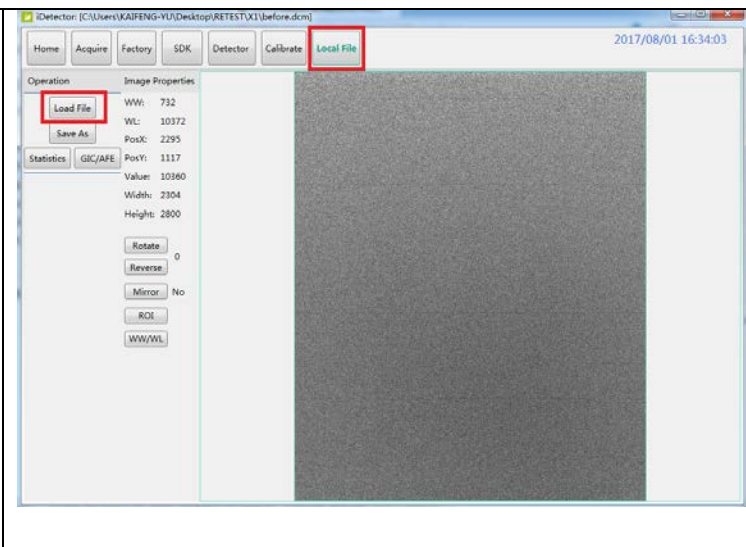
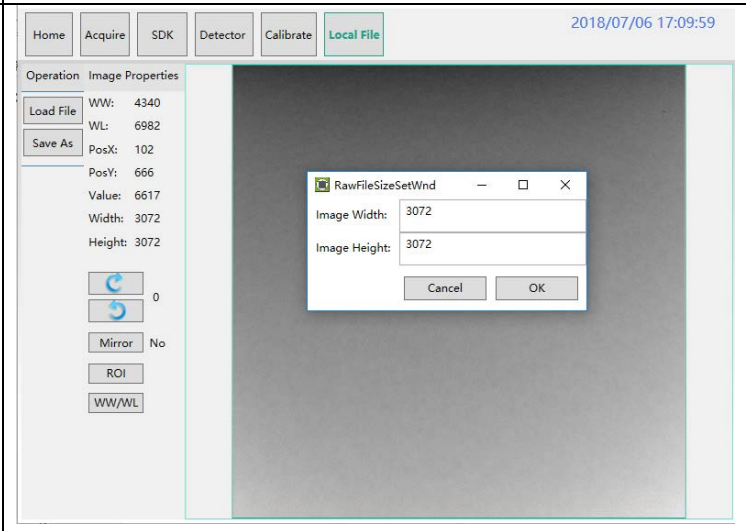

“OPEN” provides two features for image check and uploading. Local Image Check, Panel Image Upload. Local Image Check defines function to check image saved in Workstation. Panel Image Upload defines function to upload images stored in panel.

<ul style="list-style-type: none"> ● Click “Local File” button in “Local File” UI, choose the specified file ● In this page user can open the image files saved in local, the file formate can be raw, tiff, dft. When the software is disconnected to detector, the file still can be opened. 	
<ul style="list-style-type: none"> ● Click “Load File”, there will be an open file wizard. Select file and click open or double click the file. The tiff file will be opened directly. For the raw file or dft file there will be a dialog to select image size. Select correct size to open image files. If the file is not correct user will get an error message. ● Mars1717V image size: 3072*3072 	

This page provides ROI tool, which can see the AVG, SNR, and other properties of the choosen image area by right mouse button.

This page provides WW/WL tool as Acquire page . Click this button to auto adjust WW/WL based on selected area by right button of mouse.

Image Properties& Image Process	Description
WW	window width
WL	window level
PosX	X coordinates of the current cursor at the point
PosY	Y coordinates of the current cursor at the point

Value	Value of the current cursor at the point
Width	Image width
Height	Image height
	Rotate the image clockwise, 90 degrees every time.
	Rotate the image anticlockwise, 90 degrees every time.
Mirror	Open or close mirror
ROI	ROI tool, to view the image of the AVG, SV, SNR and other parameters. Press "ctrl" key, can create several ROI area.
WW/WL	Auto adjust WW/WL based on selected area by right button of mouse.

5.4 Firmware Upgrade

Panel supports upgrading firmware with IDetector, also allows the use of the Web way to upgrade the firmware, if a user needs to upgrade the firmware, please complete the following steps.

- After connecting the detector, click the “Parameters” page in “Detector”
- User can enter the upgrade UI by clicking “Upgrade Firmware” button

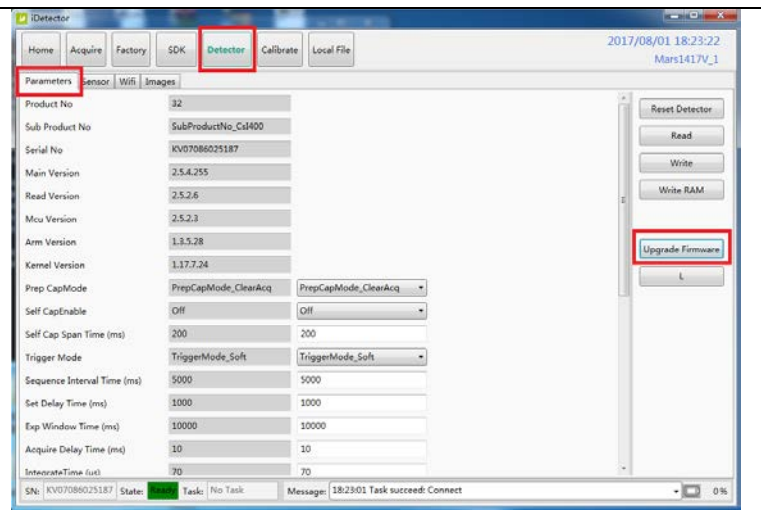

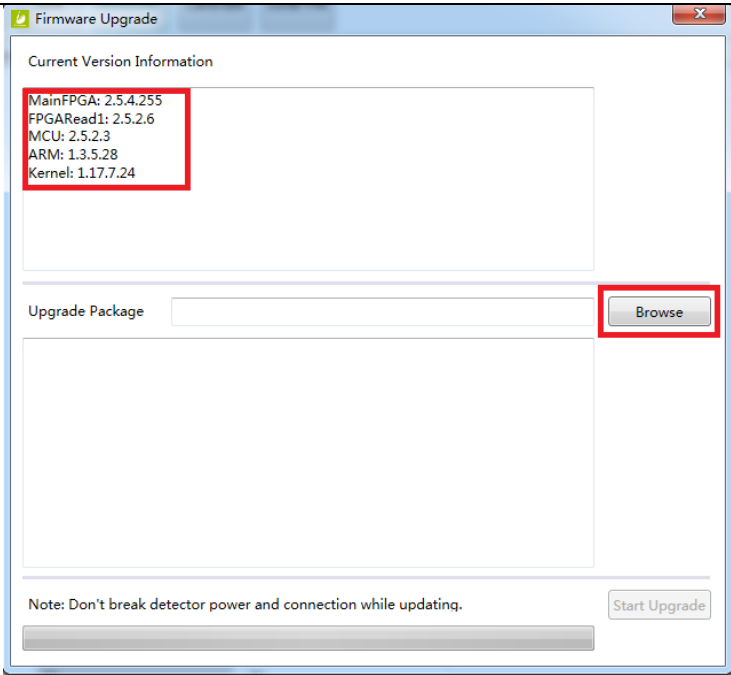
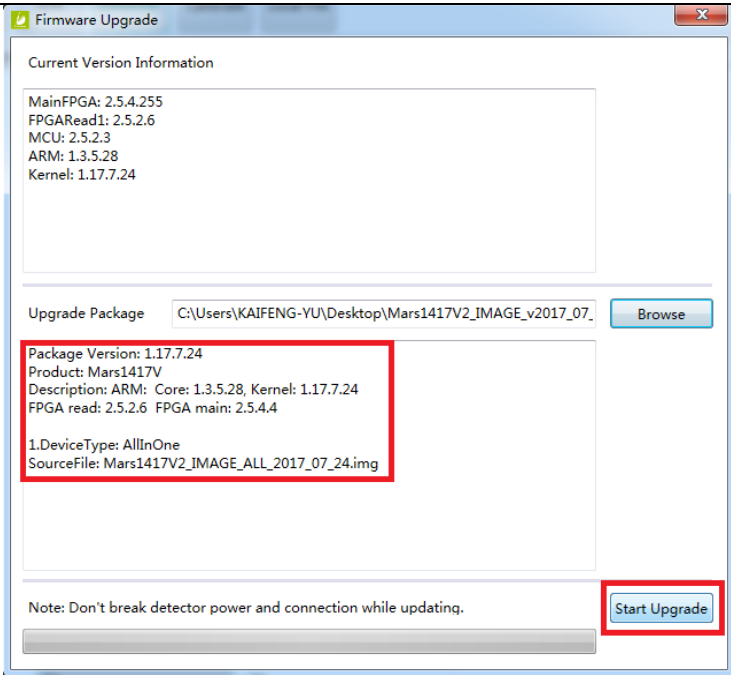
<ul style="list-style-type: none"> ● The dialog box shows the version of the current firmware ● Click “Browse” to choose the firmware file to upgrade, the extension of the file is .ifirm 	
<ul style="list-style-type: none"> ● After choosing the file, the lower dialog box shows the version of the new firmware, user should check the information and click “Start Upgrade” ● After the upgrade process is finished, power-cycle the detector 	

Note:

1. There is a progress bar for indication. Make sure battery is inserted and battery capacity is over 25%
2. Please make sure that iDetector shows “Ready”. It can also be checked by click “Config” button, there is firmware version.

5.5 Shock sensor

Some configuration of Mars1717V3 panel have the shock sensor function, the method to read out the shock log is shown as following guidance.

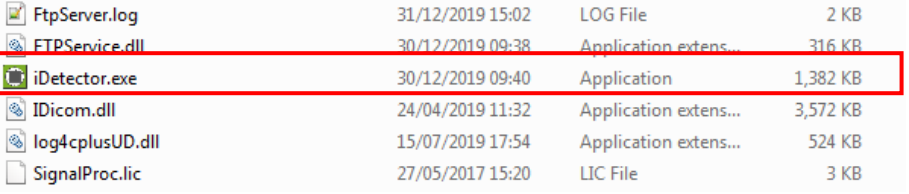
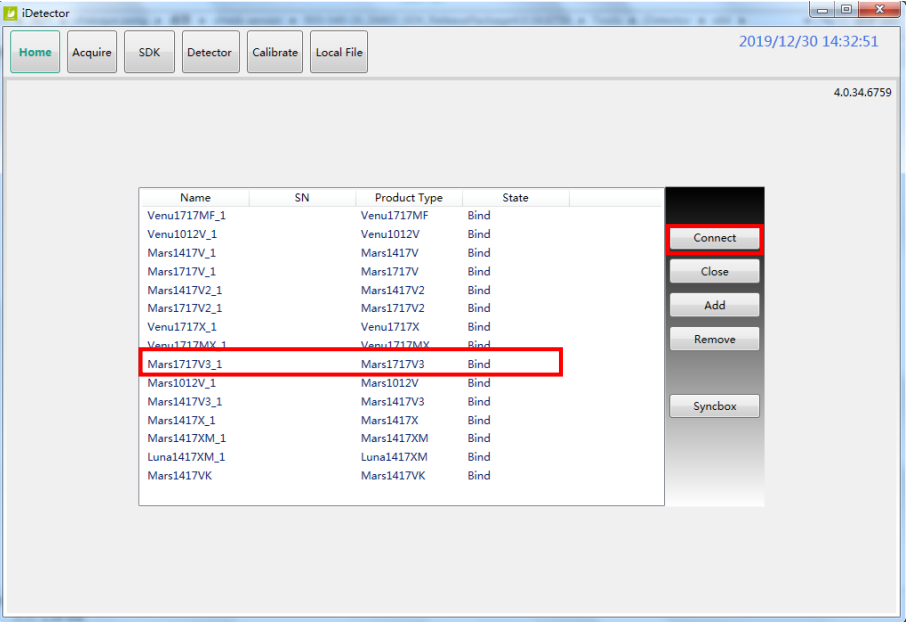
<p>1. Power on the Flat panel detector, Build connection between Flat panel detector and workstation.</p>																																																																	
<p>2. Open the idetector tool which supports shock log read out function.</p>	 <table border="1"> <thead> <tr> <th>File Name</th> <th>Date Modified</th> <th>Type</th> <th>Size</th> </tr> </thead> <tbody> <tr> <td>FtpServer.log</td> <td>31/12/2019 15:02</td> <td>LOG File</td> <td>2 KB</td> </tr> <tr> <td>FTPService.dll</td> <td>30/12/2019 09:38</td> <td>Application extens...</td> <td>316 KB</td> </tr> <tr style="border: 2px solid red;"> <td>iDetector.exe</td> <td>30/12/2019 09:40</td> <td>Application</td> <td>1,382 KB</td> </tr> <tr> <td>IDicom.dll</td> <td>24/04/2019 11:32</td> <td>Application extens...</td> <td>3,572 KB</td> </tr> <tr> <td>log4cplusUD.dll</td> <td>15/07/2019 17:54</td> <td>Application extens...</td> <td>524 KB</td> </tr> <tr> <td>SignalProc.lic</td> <td>27/05/2017 15:20</td> <td>LIC File</td> <td>3 KB</td> </tr> </tbody> </table>	File Name	Date Modified	Type	Size	FtpServer.log	31/12/2019 15:02	LOG File	2 KB	FTPService.dll	30/12/2019 09:38	Application extens...	316 KB	iDetector.exe	30/12/2019 09:40	Application	1,382 KB	IDicom.dll	24/04/2019 11:32	Application extens...	3,572 KB	log4cplusUD.dll	15/07/2019 17:54	Application extens...	524 KB	SignalProc.lic	27/05/2017 15:20	LIC File	3 KB																																				
File Name	Date Modified	Type	Size																																																														
FtpServer.log	31/12/2019 15:02	LOG File	2 KB																																																														
FTPService.dll	30/12/2019 09:38	Application extens...	316 KB																																																														
iDetector.exe	30/12/2019 09:40	Application	1,382 KB																																																														
IDicom.dll	24/04/2019 11:32	Application extens...	3,572 KB																																																														
log4cplusUD.dll	15/07/2019 17:54	Application extens...	524 KB																																																														
SignalProc.lic	27/05/2017 15:20	LIC File	3 KB																																																														
<p>3. Select Product type "Mars1717V3"; 4. Click "Connect" button.</p>	 <p>iDetector 2019/12/30 14:32:51 4.0.34.6759</p> <table border="1"> <thead> <tr> <th>Name</th> <th>SN</th> <th>Product Type</th> <th>State</th> </tr> </thead> <tbody> <tr><td>Venu1717MF_1</td><td></td><td>Venu1717MF</td><td>Bind</td></tr> <tr><td>Venu1012V_1</td><td></td><td>Venu1012V</td><td>Bind</td></tr> <tr><td>Mars1417V_1</td><td></td><td>Mars1417V</td><td>Bind</td></tr> <tr><td>Mars1717V_1</td><td></td><td>Mars1717V</td><td>Bind</td></tr> <tr><td>Mars1417V2_1</td><td></td><td>Mars1417V2</td><td>Bind</td></tr> <tr><td>Mars1717V2_1</td><td></td><td>Mars1717V2</td><td>Bind</td></tr> <tr><td>Venu1717X_1</td><td></td><td>Venu1717X</td><td>Bind</td></tr> <tr><td>Venu1717MY_1</td><td></td><td>Venu1717MY</td><td>Bind</td></tr> <tr style="border: 2px solid red;"> <td>Mars1717V3_1</td> <td></td> <td>Mars1717V3</td> <td>Bind</td> </tr> <tr><td>Mars1012V_1</td><td></td><td>Mars1012V</td><td>Bind</td></tr> <tr><td>Mars1417V3_1</td><td></td><td>Mars1417V3</td><td>Bind</td></tr> <tr><td>Mars1417X_1</td><td></td><td>Mars1417X</td><td>Bind</td></tr> <tr><td>Mars1417XM_1</td><td></td><td>Mars1417XM</td><td>Bind</td></tr> <tr><td>Luna1417XM_1</td><td></td><td>Luna1417XM</td><td>Bind</td></tr> <tr><td>Mars1417VK</td><td></td><td>Mars1417VK</td><td>Bind</td></tr> </tbody> </table> <p>Buttons: Home, Acquire, SDK, Detector, Calibrate, Local File, Connect, Close, Add, Remove, Syncbox</p>	Name	SN	Product Type	State	Venu1717MF_1		Venu1717MF	Bind	Venu1012V_1		Venu1012V	Bind	Mars1417V_1		Mars1417V	Bind	Mars1717V_1		Mars1717V	Bind	Mars1417V2_1		Mars1417V2	Bind	Mars1717V2_1		Mars1717V2	Bind	Venu1717X_1		Venu1717X	Bind	Venu1717MY_1		Venu1717MY	Bind	Mars1717V3_1		Mars1717V3	Bind	Mars1012V_1		Mars1012V	Bind	Mars1417V3_1		Mars1417V3	Bind	Mars1417X_1		Mars1417X	Bind	Mars1417XM_1		Mars1417XM	Bind	Luna1417XM_1		Luna1417XM	Bind	Mars1417VK		Mars1417VK	Bind
Name	SN	Product Type	State																																																														
Venu1717MF_1		Venu1717MF	Bind																																																														
Venu1012V_1		Venu1012V	Bind																																																														
Mars1417V_1		Mars1417V	Bind																																																														
Mars1717V_1		Mars1717V	Bind																																																														
Mars1417V2_1		Mars1417V2	Bind																																																														
Mars1717V2_1		Mars1717V2	Bind																																																														
Venu1717X_1		Venu1717X	Bind																																																														
Venu1717MY_1		Venu1717MY	Bind																																																														
Mars1717V3_1		Mars1717V3	Bind																																																														
Mars1012V_1		Mars1012V	Bind																																																														
Mars1417V3_1		Mars1417V3	Bind																																																														
Mars1417X_1		Mars1417X	Bind																																																														
Mars1417XM_1		Mars1417XM	Bind																																																														
Luna1417XM_1		Luna1417XM	Bind																																																														
Mars1417VK		Mars1417VK	Bind																																																														

5. After Connected the panel,click “Detector” section;

6. Choose “Sensor” page;

7. Click “Read Shock Log” button;

8. The shock log will be read out from panel and recorded as an txt file called “ShockLog.txt”i n the work dir path. After the read process is finished, the message will indicate as “Task succeed: UploadShockLog”

9. The Shock log will be generated in the following path:
 ...\\iDetector\x64\work_dir\Mars1717V3

10. Freefall record levels:

In the Mars1717V3 panel, the shock log level and freefall height

Freefall height	Shock Log Level	Records
<30cm	Low Risk Freefall	● Not recorded.
≥30cm <70cm	Normal Risk Freefall	<ul style="list-style-type: none"> ● Recorded in middle risk logs ● When over 5 times of this level freefall recorded, each new normal risk freefall will be also recorded in high risk logs.
≥70cm	High risk freefall	● Recorded in high risk logs.

11. Open the Shock Log file, the log is indicated as shown in figure right.

The meaning of read out will be:

12. When there is no freefall over 30cm recorded in the panel.

13. Shock log read out time

14. Normal Risk logs:
Record of medium risk freefall |Time of this freefall happened(reference to the RTC inside the panel)

15. High risk logs:
Record of high risk freefall |Time of this freefall happened (reference to the RTC inside the panel).

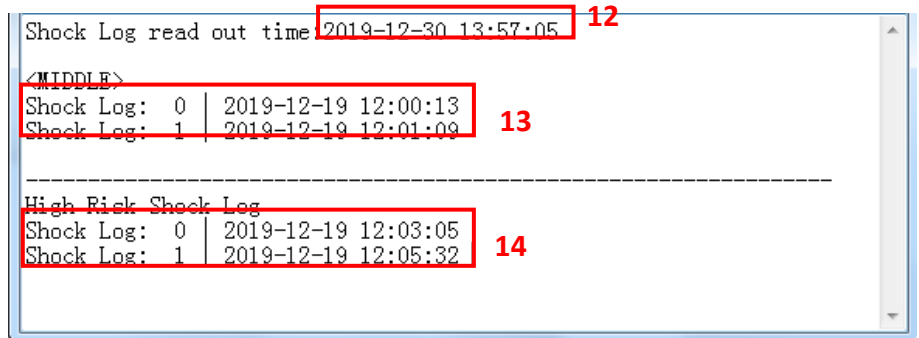
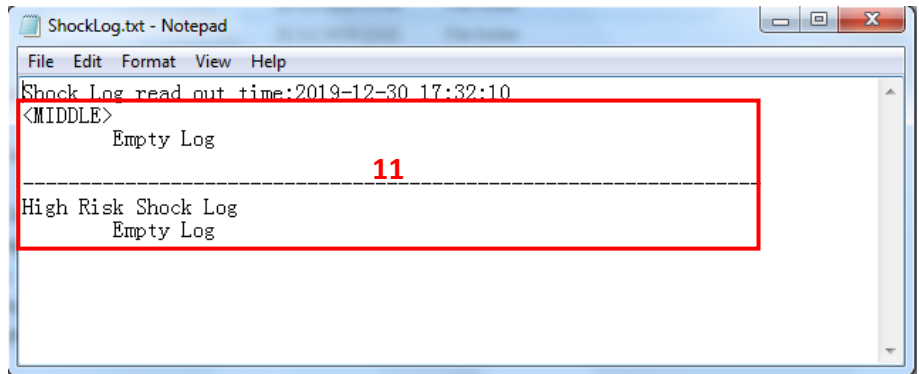

SYNC RTC:

In order to make the shocklog time consistent with the local time, you need to synchronize the RTC of the panel with the local time.

The method of sync RTC is:

- Perform steps of this document to step 6 : choose "Sensor" page;
- Click button "sync time" and the panel RTC time will be set as workstation local time.

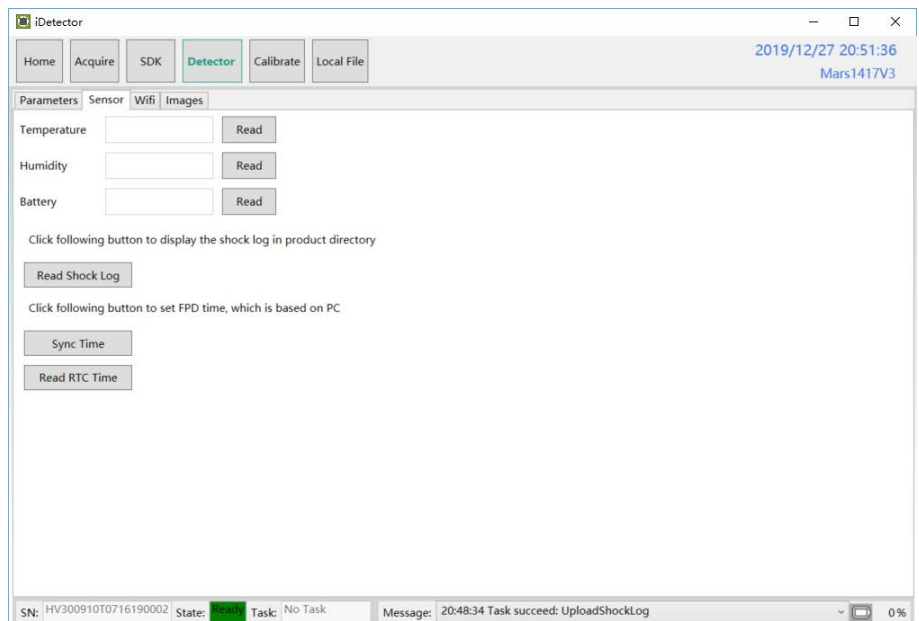

6. Regulatory Information

6.1 Medical equipment safety standards.....	93
6.2 Guidance and manufacture's declaration for EMC	95
6.2.1 <i>EMI Compliance Table</i>	95
6.2.2 <i>EMS Compliance Table</i>	95
6.3 Radio Frequency Compliance Information	98
6.3.1 <i>FCC Compliance</i>	99
6.4 Battery Safety Standards.....	99

6.1 Medical equipment safety standards

◆ Medical equipment classification

Type of protection against electrical shock	External electrical power source equipment Class I Equipment (medical approved adaptor) Internal electrical power source equipment (battery)
Degree of protection against electrical shock	Type-B applied part
Degree of protection against ingress of water	IPX1
Mode of operation	Continuous operation
Flammable anesthetics	Not suitable for use in the presence of a flammable anesthetic mixture with air or with oxygen or nitrous oxide Not suitable for use in the oxygen rich environment

◆ Product safety standards r

MDD (93/42/EEC)	Medical Device Directive
<i>Directive 2011/65/EU</i>	<i>Restriction of the use of certain hazardous substances (RoHS)</i>
EN ISO 13485:2016	Medical devices– Quality management systems– Requirements for regulatory purposes
EN ISO14971: 2012	Medical device – Application of risk management to medical devices
IEC 60601 1: 2005 + CORR. 1 (2006) + CORR. 2 (2007) + AM1 (2012)	Medical electrical equipment –Part 1: General requirements for basic safety and essential performance
EN 60601-1:2006+A11:2011+A1:2013+A12:2014	Medical electrical equipment – Part 1: General requirements for basic safety and essential performance
BS EN 60601-1:2006+A11:2011	Medical electrical equipment –Part 1: General requirements for basic safety and essential performance

ANSI/AAMI ES60601-1:2005/(R)2012+A1:2012+C1:2009/(R)2012+A2:2010/(R)2012	Medical electrical equipment – Part 1: General requirements for basic safety and essential performance
CAN/CSA-C22.2 No.60601-1:14	Medical electrical equipment –Part 1: General requirements for basic safety and essential performance
IEC 60601-2-54:2009+A1:2015	Medical electrical equipment –Part 2-54: Particular requirements for the basic safety and essential performance of X-ray equipment for radiography and radioscopy
CAN/CSA-C22.2 NO. 60601-2-54:11	Medical electrical equipment –Part 2-54: Particular requirements for the basic safety and essential performance of X-ray equipment for radiography and radioscopy
IEC 60601-1-6:2010+A1:2013	Medical electrical equipment Part 1-6: General requirements for basic safety and essential performance — Collateral standard: Usability
CAN/CSA-C22.2 NO. 60601-1-6:11+A1:2015	Medical electrical equipment Part 1-6: General requirements for basic safety and essential performance — Collateral standard: Usability
EN 60601-1-6:2010+A1:2015	Medical electrical equipment Part 1-6: General requirements for basic safety and essential performance — Collateral standard: Usability
EN 60601-1-2:2015	Medical electrical equipment – Part 1-2: General requirements for basic safety and essential performance– Collateral standard: Electromagnetic disturbances– Requirements and tests
IEC 62133:2012	Secondary cells and batteries containing alkaline or other non-acid electrolytes – Safety requirements for portable sealed secondary cells, and for batteries made from them, for use in portable applications
EN 62220-1:2004	Medical electrical equipment – Characteristics of digital X-ray imaging devices–Part 1: Determination of the detective quantum efficiency

EN 62304:2006/AC:2008	Medical device software – Software life-cycle processes
EN 62366:2008	Medical devices – Application of usability engineering to medical devices
ANSI/AAMI ES60601-1:2005+ Amendment 1:2012+ Amendment 2:2010	Medical Electrical Equipment – Part 1: General requirements for safety and essential performance
CAN/CSA C22.2 No. 60601-1-14	Medical Electrical Equipment – Part 1: General requirements for safety and essential performance
ISO 15223-1:2016	Medical devices-symbols to be used with medical device labels, labeling and information to be supplied–Part1:General requirements

6.2 Guidance and manufacture' s declaration for EMC

6.2.1 EMI Compliance Table

◆ Emissions

Phenomenon	Compliance	Electromagnetic environment
RF emissions	CISPR 11 Group 1, Class B	Professional healthcare facility environment
Harmonic distortion	IEC 61000-3-2 Class A	Professional healthcare facility environment
Voltage fluctuations and flicker	IEC 61000-3-3 Compliance	Professional healthcare facility environment

6.2.2 EMS Compliance Table

◆ Enclosure Port

Phenomenon	Basic EMC standard	Immunity test levels
		Professional healthcare facility environment
Electrostatic Discharge	IEC 61000-4-2	±8 kV contact ±2kV, ±4kV, ±8kV, ±15kV air

Radiated RF EM field	IEC 61000-4-3	3V/m 80MHz-2.7GHz 80% AM at 1kHz
Near fields from RF wireless communications equipment	IEC 61000-4-3	Refer to table "Near fields from RF wireless communications equipment"
Rated power frequency magnetic fields	IEC 61000-4-8	30A/m 50Hz or 60Hz

◆ Near fields from RF wireless communications equipment

Test frequency (MHz)	Band (MHz)	Immunity test levels
		Professional healthcare facility environment
385	380-390	Pulse modulation 18Hz, 27V/m
450	430-470	FM, ± 5 kHz deviation, 1kHz sine, 28V/m
710	704-787	Pulse modulation 217Hz, 9V/m
745		
780		
810	800-960	Pulse modulation 18Hz, 28V/m
870		
930		
1720	1700-1990	Pulse modulation 217Hz, 28V/m
1845		
1970		
2450	2400-2570	Pulse modulation 217Hz, 28V/m
5240	5100-5800	Pulse modulation 217Hz, 9V/m
5500		
5785		

◆ Input a.c. power port

Phenomenon	Basic EMC standard	Immunity test levels
		Professional healthcare facility environment
Electrical fast transients/burst	IEC 61000-4-4	±2 kV 100kHz repetition frequency
Surges Line-to-line	IEC 61000-4-5	±0.5 kV, ±1 kV
Surges Line-to-ground	IEC 61000-4-5	±0.5 kV, ±1 kV, ±2 kV
Conducted disturbances induced by RF fields	IEC 61000-4-6	3V, 0.15MHz-80MHz 6V in ISM bands between 0.15MHz and 80MHz 80%AM at 1kHz
Voltage dips	IEC 61000-4-11	0% UT; 0.5 cycle At 0°, 45°, 90°, 135°, 180°, 225°, 270° and 315°
		0% UT; 1 cycle and 70% UT; 25/30 cycles Single phase: at 0°
Voltage interruptions	IEC 61000-4-11	0% UT; 250/300 cycles

- Recommended separation distances between portable or mobile RF communication device and detector:
- Portable RF communications equipment, including antennas, can effect medical electrical equipment. The warning should include a use distance such as “be used no closer than 30 cm (12 inches) to any part of the [ME EQUIPMENT or ME SYSTEM], including cables specified by the manufacturer”

◆ **The following shows information on reference cables provided against EMC**

Cable	Recommended cable length	Shielded	or	Number	Cable classification
		Unshielded			

AC Power Cable	3m	Unshielded	1 pcs	AC Power
DC Power Cable	3.5m	Unshielded	1 pcs	DC Power
LAN Cable (configuration mode)	3m	Shielded	1 pcs	Signal

◆ Important information regarding Electromagnetic Compatibility (EMC)

Mars1717V requires special precautions regarding EMC and needs to be installed only by iRay or authorized personnel and put into service according to EMC information provided in the user manual. Mars1717V in use may be susceptible to electromagnetic interference from portable and mobile RF communications such as mobile (cellular) telephones. Electromagnetic interference may result in incorrect operation of the system and create a potentially unsafe situation.

Mars1717V conforms to this EN60601-1-2:2015 standard for both immunity and emissions.

Nevertheless, special precautions need to be observed:

The use of accessories, transmitters and cables other than those specified by this User Manual, with the exception of accessories and cables sold by iRay of Mars1717V as replacement parts for inner components, may result in increased emission or decreased immunity.

6.3 Radio Frequency Compliance Information

Country	Item
U.S.A.	KDB 865664 D01 47 CFR part 15, subpart B 47 CFR part 15, subpart C 15.247 47 CFR part 15, subpart C 15.407 47 CFR §2.1091 KDB447498 D01 General Exposure Guidance v06
European Union	EN 301 489-1 V 2.1.1 EN 301 489-17 V 3.1.1 EN 300 440 V 2.1.1 EN 300 328 V 2.1.1; EN 301 893 V 2.1.1

	EN 62311:2008 EN 62209-2:2010 EN 50566:2017 EN 62476:2010 EN 55032:2015 EN 61000-3-2:2014 EN 61000-3-3:2013
--	---

6.3.1 FCC Compliance

- The panel has been tested to comply with limits for a Class B digital device, pursuant to part 15 of FCC Rules. These limits are designed to provide reasonable protection against harmful interference in a residential installation.
- Operation is subject to the following two conditions.

The panel may not cause harmful interference.

The panel must accept any interference received, including interference that may cause undesired operation.

- The panel generates, uses, and radiates radio frequency energy and, if not installed and used in accordance with the instruction, may cause harmful interference to radio communications. However, there is no guarantee that interference will not occur in a particular installation. If the panel does cause harmful interference to radio or television reception, which can be determined by turning the panel off and on, the user is encouraged to correct the interference by one or more of the following measure.
 - Reorient or relocate the antenna.
 - Increase the separation between the panel and receiver.
 - Connect the panel into an outlet different from the receiver is connected.
 - Consult the distributor or an experienced radio/TV technician for help.

6.4 Battery Safety Standards

Standards	Description
IEC 62133:2012	Secondary cells and batteries containing alkaline or other non-acid electrolytes
UN38.3	United Nations Recommendations on the Transport of dangerous goods Manual of tests and Criteria ST/SG/AC.10/11/Rev.5/Amend.1&Amend.2

7. Trouble Shooting

TROUBLE SHOOTING.....	101
------------------------------	------------

Please refer to service manual. If the problem persists, turn off the panel and contact iRay service department (service@iraygroup.com). We would provide the best service.

8. Service Information

8.1 Product Lifetime.....	103
8.2 Regular Inspection and Maintenance.....	103
8.3 Repair	103
8.4 Replacement Parts Support	103

8.1 Service Office Info

Service Office
Tel: +86 21 50720560
Fax: +86 21 50720561
E-mail: service@iraygroup.com
Location: No.33 Xinggang Road, Taicang Port Economic and
Technological Development Zone, Jiangsu, China PC: 215434

8.2 Product Lifetime

The estimated product lifetime is up to 5 years under appropriate regular inspection and maintenance.

8.3 Regular Inspection and Maintenance

In order to ensure the safety of patients and operator, to maintain the performance and reliability of the panel, be sure to perform regular inspection at least once a year. If necessary, clean up the panel, make adjustments or replace consumables such as fuses etc. There may be cases where overhaul is recommended depending on conditions. Contact iRay service office or local iRay dealer for regular inspection or maintenance.

8.4 Repair

If problem cannot be solved, contact your sales representative or local iRay dealer for repairs. Please refer to the label and provide the following information:

Product Name:

Series Number:

Description of Problem: as clearly as possible.

8.5 Replacement Parts Support

Main parts (parts required to maintain the function of the product) of this product will be stocked for 5 years after discontinuance of production for repairing.

Appendix

<i>Appendix A Information of Manufactures</i>	106
---	-----

Appendix A Information of Manufactures



Company: iRay Korea Limited

ADDRESS: 1833, 18F, 5, Gasan digital 1-ro, Geumcheon-gu, Seoul, Republic of Korea 08594